

Lindab Coverline™

# Lindab Flashings Technical Information

# Technical Facts

## Coverline flashings

### ÖB Top flashing

Dim
B, mm
40
60
80
100
120
150

Lengths as current price list.

SE

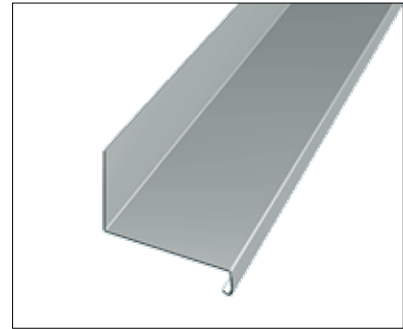
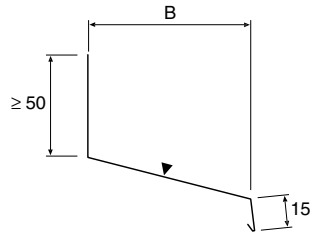

### UB Still flashing

Dim
B, mm
40
60
80
100
120
150
170
190

Nail holes as standard, cc 100 mm.

Lengths as current price list.

Can be supplied with end pieces to order.

SE

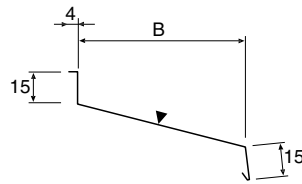

### VABR Weatherboard flashing

Dim
mm
105
140

Lengths as current price list.

SE

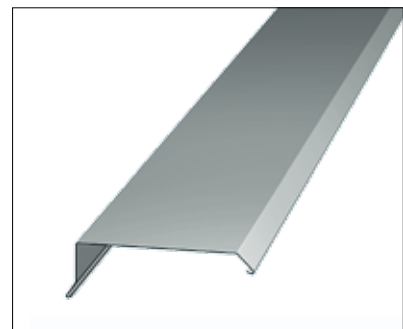
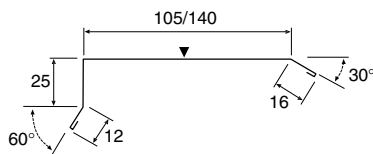

# Technical Facts

## Coverline flashings

### VISK Barge board flashing

Dim
mm
120

Lengths as current price list.

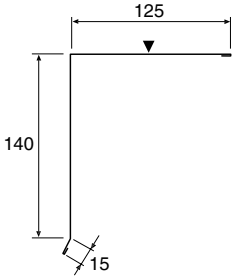

SE

### VISK Barge board flashing

Dim
mm
55
110

Lengths as current price list.

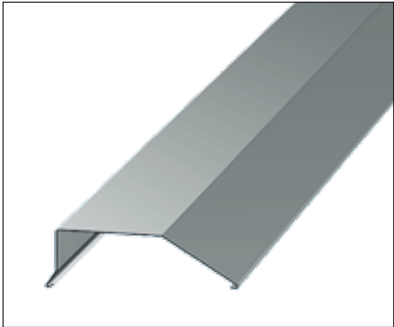
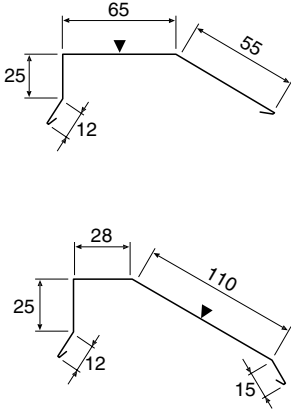

SE

### FOTP Eaves board

Lengths as current price list.



SE

# Technical Facts

## Coverline flashings

### FOTPA Eaves board

Lengths as current price list.

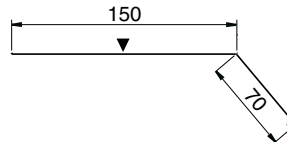

SE

### RD Valley gutter

Made to taper.

Lengths as current price list.

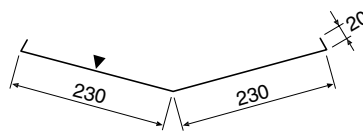

SE

### TRBL Drip flashing

Lengths as current price list.

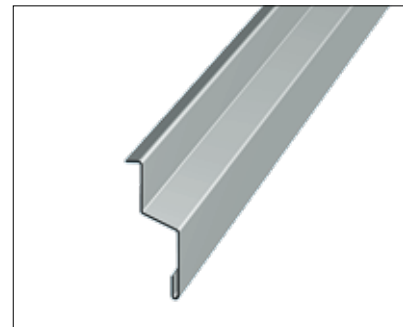
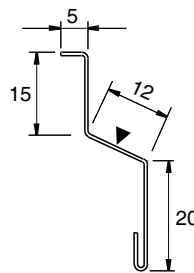

SE

### NP120/NP170 Ridge capping

Dim  
mm

120

170

Lengths as current price list.

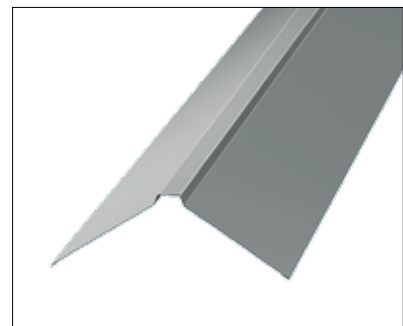
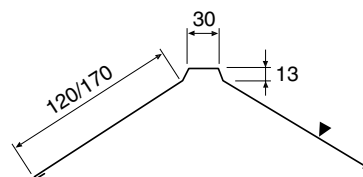

SE

# Technical Facts

## Coverline flashings

### NTP Ridge capping

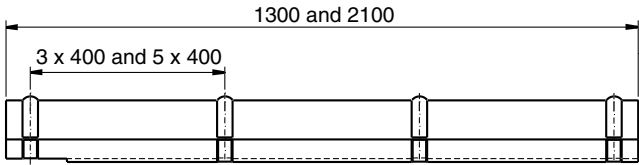

Cover lengths 1200 mm and 2000 mm.

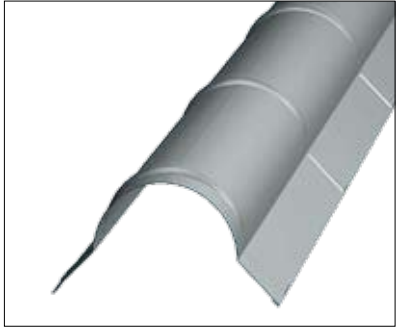
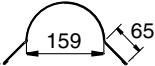

SE

### STÅSK Apron flashing

Lengths as current price list.

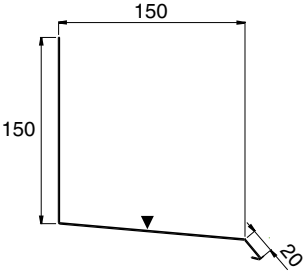

SE

### HBI/HBY Corner flashing

Lengths as current price list.

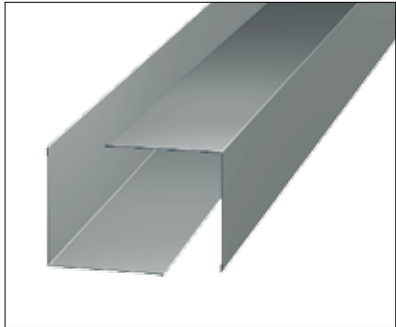
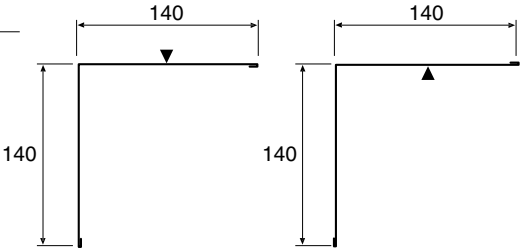

SE

# Technical Facts

## Coverline flashings

### Filler blocks

Across panels at ridges, eaves etc.

Cladding	Small block	Large block
LTP20 LVP20	TPL20	TPS20
LLP20	TLL20	TLL20
SIN	CTP	CTP
LV30 LW30	TPL30	TPS30
LTP45 LVP45	TPL45	TPS45
LTP115 LVP115	TPL115	TPS115

### Along panel at side overlap etc.

A self-adhesive sealing strip TBA 10x3 mm is used for all profiles.

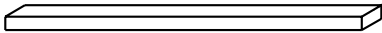

SE

### ANE Connection panel for LLP20

Panel thickness	Weight kg/each
0.6	4.50

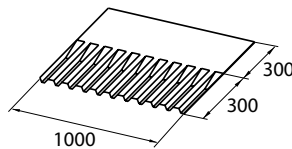

SE

# Technical Facts

## Coverline flashings for Sandwich Panels

### S1 Ridge Capping

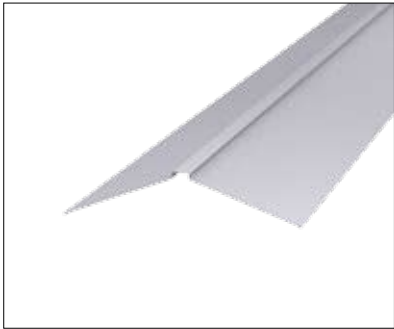
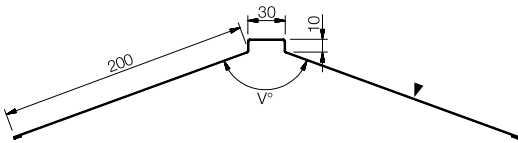

DE

### S2 Internal Flashing

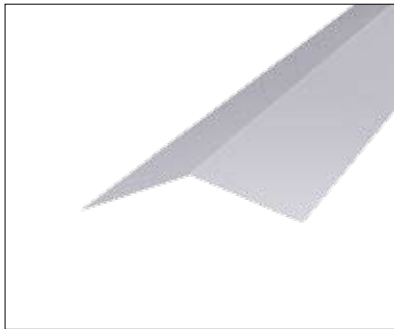
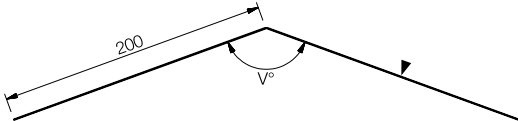

DE

### S3 Eaves Flashing

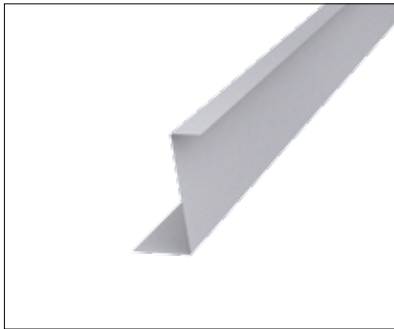
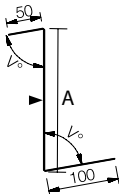

DE

### S4 Eaves Flashing

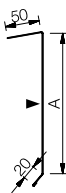

DE

# Technical Facts

## Coverline flashings for Sandwich Panels

### S5 Eaves Flashing

---

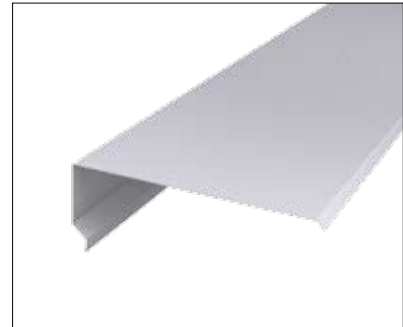
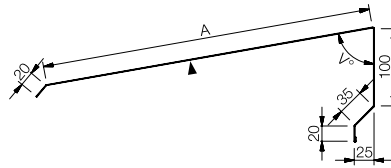

DE

---

### S6 Gable Flashing

---

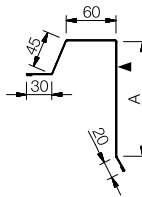

DE

---

### S7 Galbe Flashing Support Angel

---

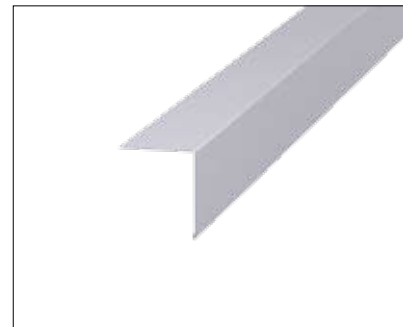
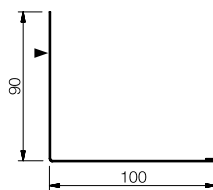

DE

---

### S9 Corner Flashing

---

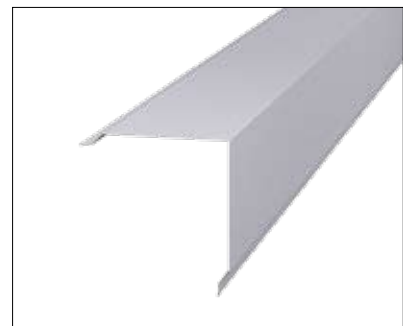
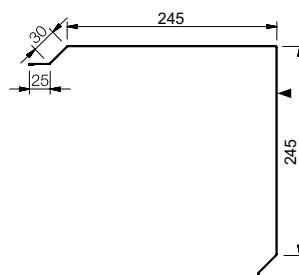

DE



## Coverline flashings for Sandwich Panels

### S10 Pilaster

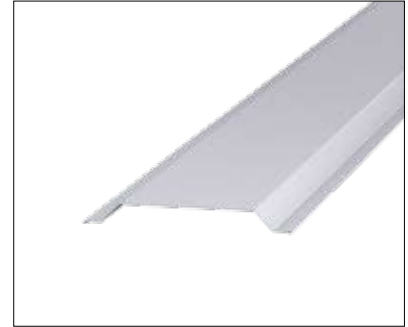
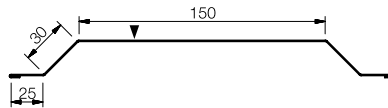

DE

### S11 Base Cover Flashing Exterior

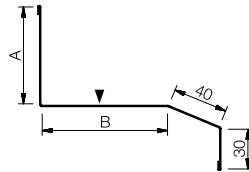

DE

### S12 Base Cover Flashing Interior

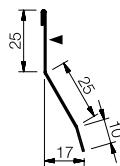

DE

### S13 Underbeslag tak/vägg långsida invändigt

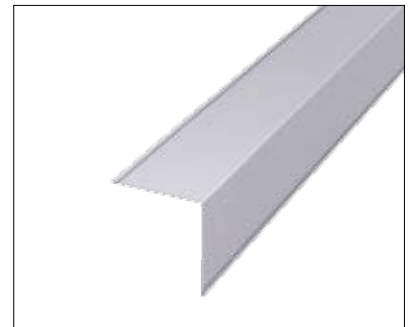
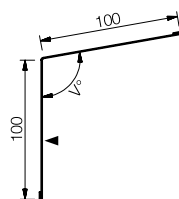

DE

## Coverline flashings for Sandwich Panels

### S14 Still Flashing Long Side Exterior

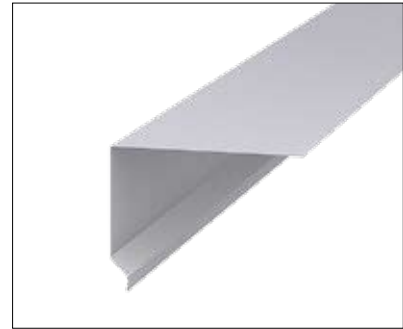
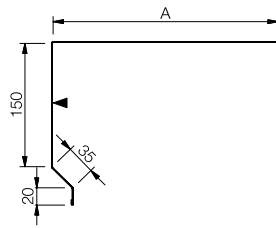

DE

### S15 Still Flashing Long Side Interior

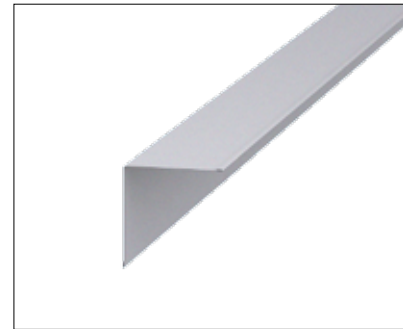
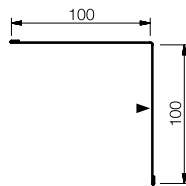

DE

### S16 Case Flashing

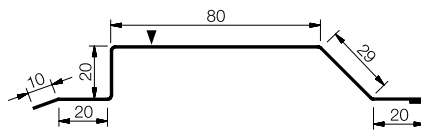

DE

### S17 Drip Flashing

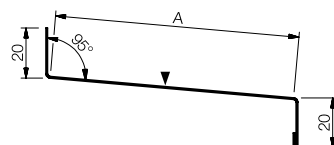

DE

## Coverline flashings for Sandwich Panels

### S18 Window Flashing

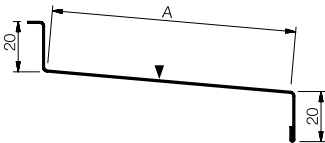

DE

### S19 Runner Monowall

Dim mm	A mm
80	55
100	75
120	95

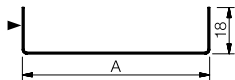

DE

### S20 Runner Hipertec

Dim mm	A mm
100	80
120	100
150	130

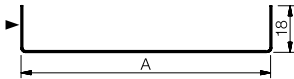

DE



Lindab Profile is a business area within the Lindab Group that develops, manufactures, and markets efficient, economical and aesthetic steel and sheet-metal solutions for the building industry.

We offer everything from complete building systems to individual building components for all types of housing, as well as commercial and industrial buildings.

Lindab Profile is represented in over 25 countries throughout Europe. Our head office is in Förslöv, in the south of Sweden.



**Lindab Profile**  
SE-269 82 Båstad  
Phone +46 (0)431 850 00  
[www.lindab.com](http://www.lindab.com)