





















































# Lindab **Valves**

Mounting instructions

# Overview diffusers, valves and cover

Unit				Connects to						
				Socket with thread for units with bayonet holder		Socket with groove for units with spring holder		Cover socket with groove for units with wire spring holder	Smooth socket for units with plate spring holder	Duct/Fitting
Supply air	VTK	Dif-fuser			VRFU 	VRFM 	VRR 			
	VTTB	Dif-fuser			VRFU 	VRFM 	VRR 			
	SHH	Dif-fuser								Duct
	KPT	Valve						IL 		Duct/ Fittings
	KI	Valve		VRGU 	VRGL 	VRGM 				
	KIR	Valve		VRGU 	VRGL 	VRGM 				
Supply and exhaust air	TAV	Valve								Duct

Unit				Connects to							
				Socket with thread for units with bayonet holder			Socket with groove for units with spring holder		Cover socket with groove for units with wire spring holder	Smooth socket for units with plate spring holder	Duct/Fitting
Exhaust air	<b>KVB</b>	Valve					<b>VRFU</b> 	<b>VRFM</b> 	<b>VRR</b> 		
	<b>KDPF</b>	Valve		<b>VRGU</b> 	<b>VRGL</b> 	<b>VRGM</b> 	<b>VRFU</b> 	<b>VRFM</b> 	<b>VRR</b> 		
	<b>KVG</b> Ø 100–160	Valve					<b>VRFU</b> 	<b>VRFM</b> 	<b>VRR</b> 		
	<b>KVG</b> Ø 200	Valve		<b>VRGU</b> 	<b>VRGL</b> 	<b>VRGM</b> 					
	<b>KU</b>	Valve		<b>VRGU</b> 	<b>VRGL</b> 	<b>VRGM</b> 					
	<b>KSU</b>	Valve		<b>VRGU</b> 	<b>VRGL</b> 	<b>VRGM</b> 					
	<b>KPF</b>	Valve								<b>IL</b> 	Duct/Fitting
No air	<b>TLO</b>	Cover					<b>VRFU</b> 	<b>VRFM</b> 	<b>VRR</b> 		

# When to use the different k-factor types

k-factor type: B (Bend 90°)

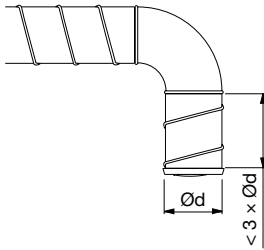

k-factor type: D (Duct)

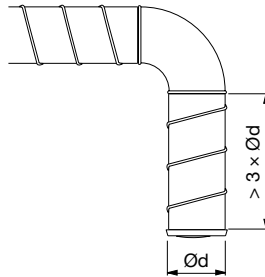

k-factor type: T (T-piece)

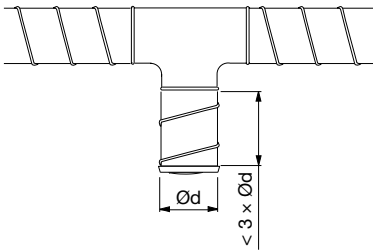

k-factor type: D (Duct)

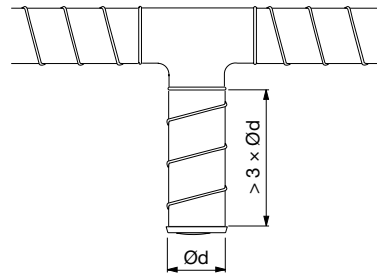

## Explanations

### Measurement of air flow

$$q = k \cdot \sqrt{\Delta p_m} \quad \Delta p_m = \left( \frac{q}{k} \right)^2$$

where

q	is air flow	[l/s]
$\Delta p_m$	is measuring pressure difference	[Pa]
k	is correction factor, see table	[-]

### Tables

a	is setting of valve disc or cone	[mm]
n	is setting of valve disc or cone	[number of opening turns]
D	is valve mounted in a duct	
B	is valve mounted in a bend 90°	
T	is valve mounted in a T-piece	

WOSP is without sector plate

WSP is with sector plate



is recommended method



is not recommended method

# Diffuser

## WTK

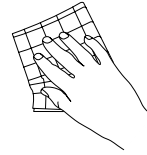
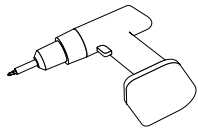

Ø125  
Alt 1

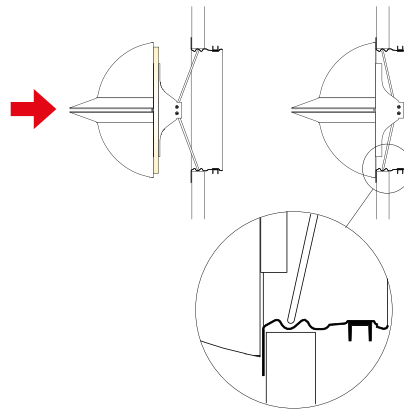
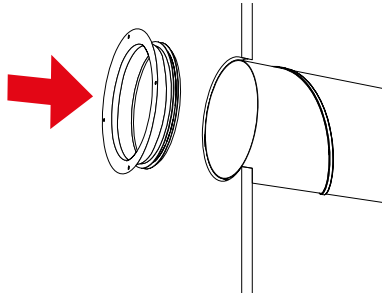
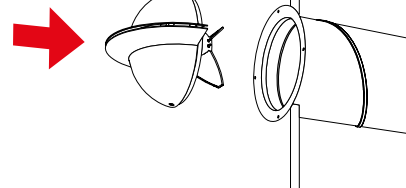
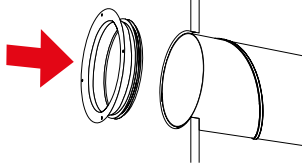

Ø100

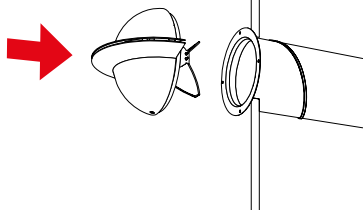

Ø125  
Alt 2

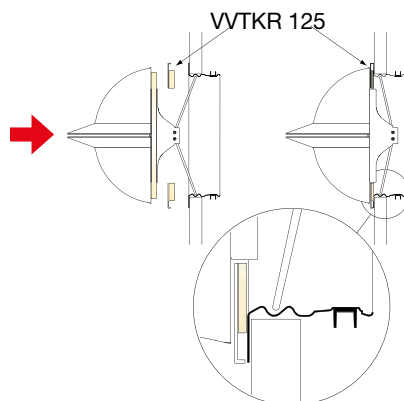
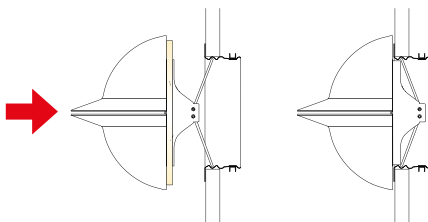
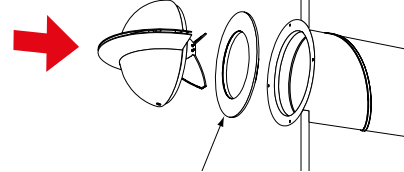

# Diffuser

## WTK

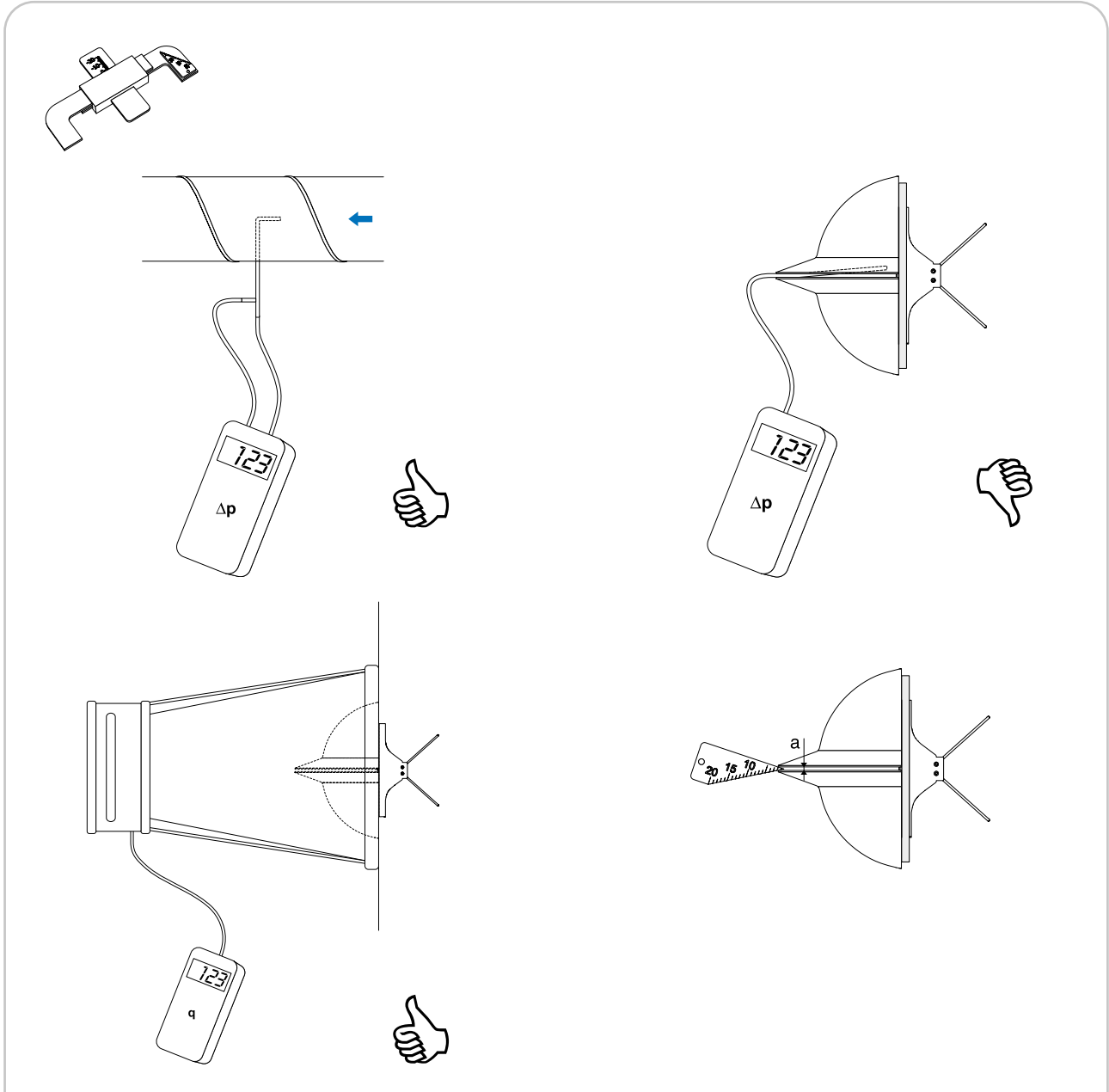

K-factors apply only to products produced after Oct 1, 2025.

Ø mm	Valve mounted in	Setting a [mm]				
		a	5	7	9	12
100	Duct	k	2,30	3,00	3,80	4,60
		a	5	7	9	12
125	Duct	k	2,30	3,00	3,80	4,60
		a	5	7	9	12

# Diffuser

## WTK

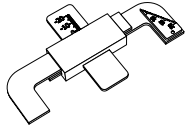

Ø mm	Valve mounted in	Setting a [mm]						
		a	6	8	10	12		
100	Duct	k	1,14	1,44	1,85	2,48		
		a	6	7	8	10	12	16
125	Duct	k	1,25	1,51	1,87	2,16	2,73	3,61

# Diffuser

## VTTB

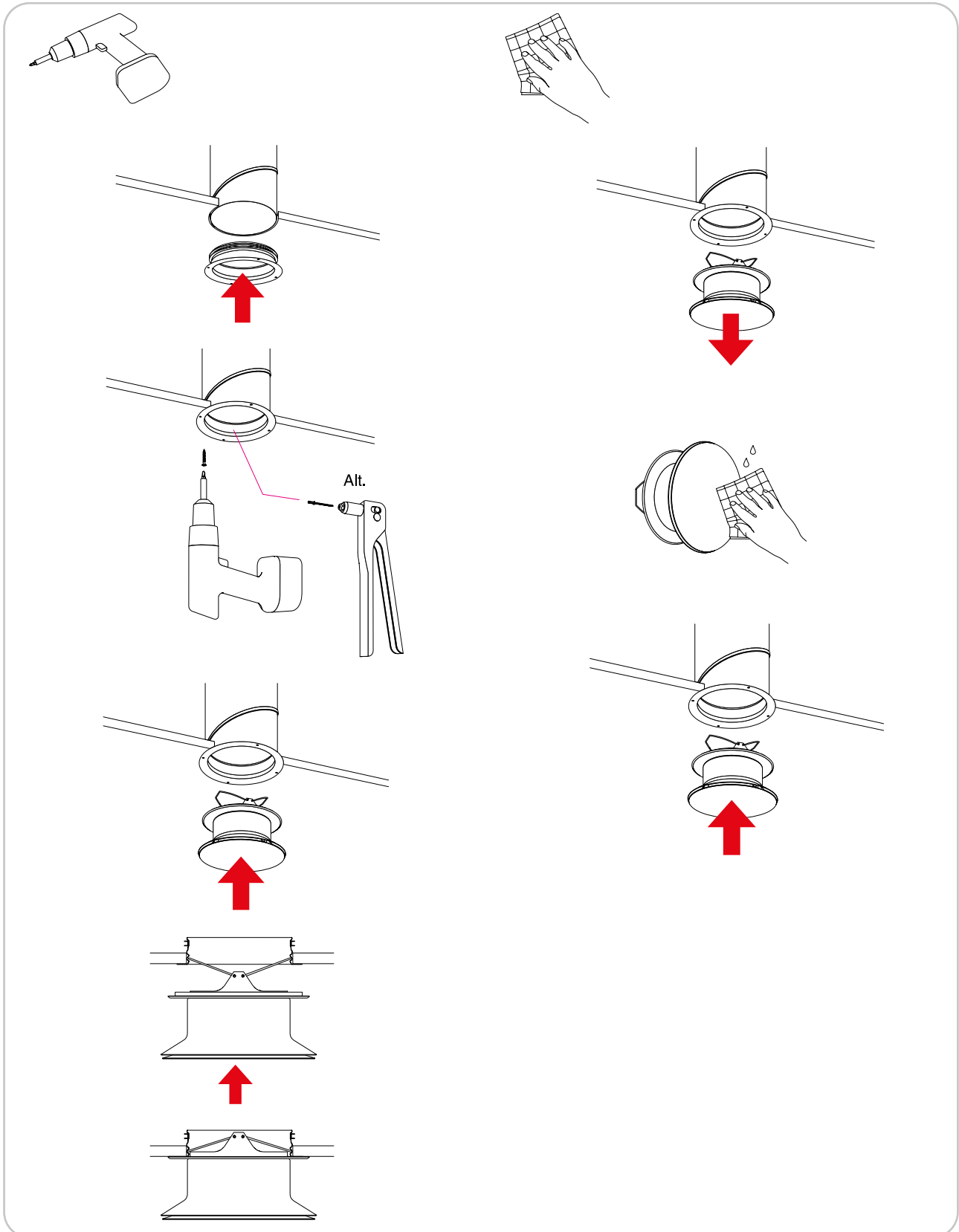

# Diffuser

## VTTB

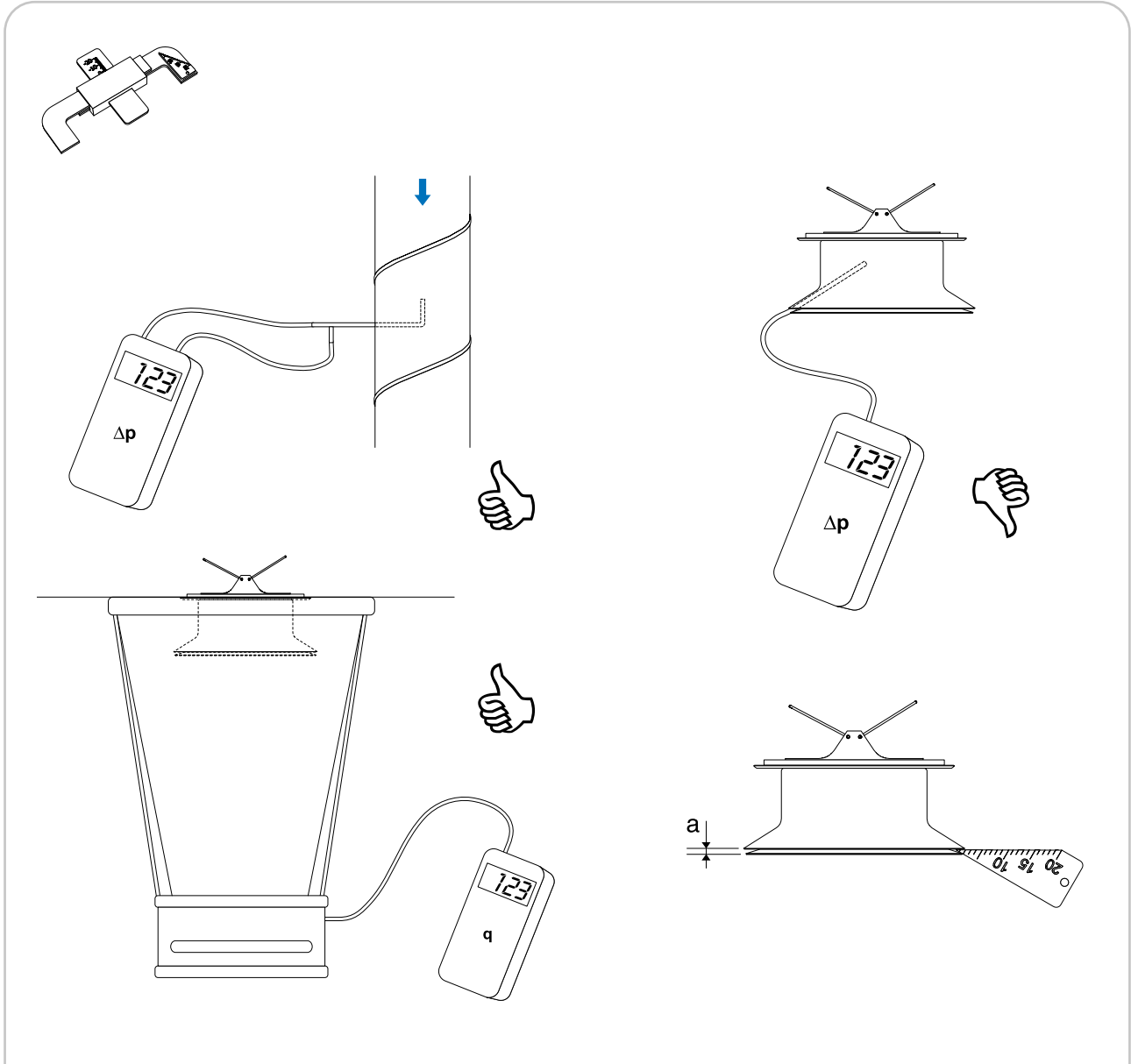

K-factors apply only to products produced after Oct 1, 2025.

Ø mm	Valve mounted in	Setting a [mm]						
		a	2	4	6	9	12	Fully open
100	Duct	k	0,80	1,60	2,30	3,30	4,40	5,20
		a	4	5	7	9	12	Fully open
125	Duct	k	2,00	2,40	3,30	4,00	5,00	5,40
		a	4	6	9	12	Fully open	
160	Duct	k	2,20	3,20	4,60	5,90	7,20	
		a	4	6	9	12	Fully open	

# Diffuser

## VTTB

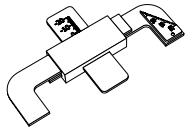

Ø mm	Valve mounted in	Setting a [mm]									
		a	4	5	6	7	8	10	12	16	
100	Duct	k	1,29	1,43	1,82	2,01	2,34	2,98	3,46	4,34	
		a	4	5	6	7	8	10	12	16	
125	Duct	k	1,54	1,98	2,28	2,71	3,20	3,90	4,52	5,85	
		a	5	6	7	8	10	12	16	20	
160	Duct	k	2,60	3,23	3,71	3,94	5,03	5,83	7,33	8,40	
		a	5	6	7	8	10	12	16	20	

# Diffuser

SHH

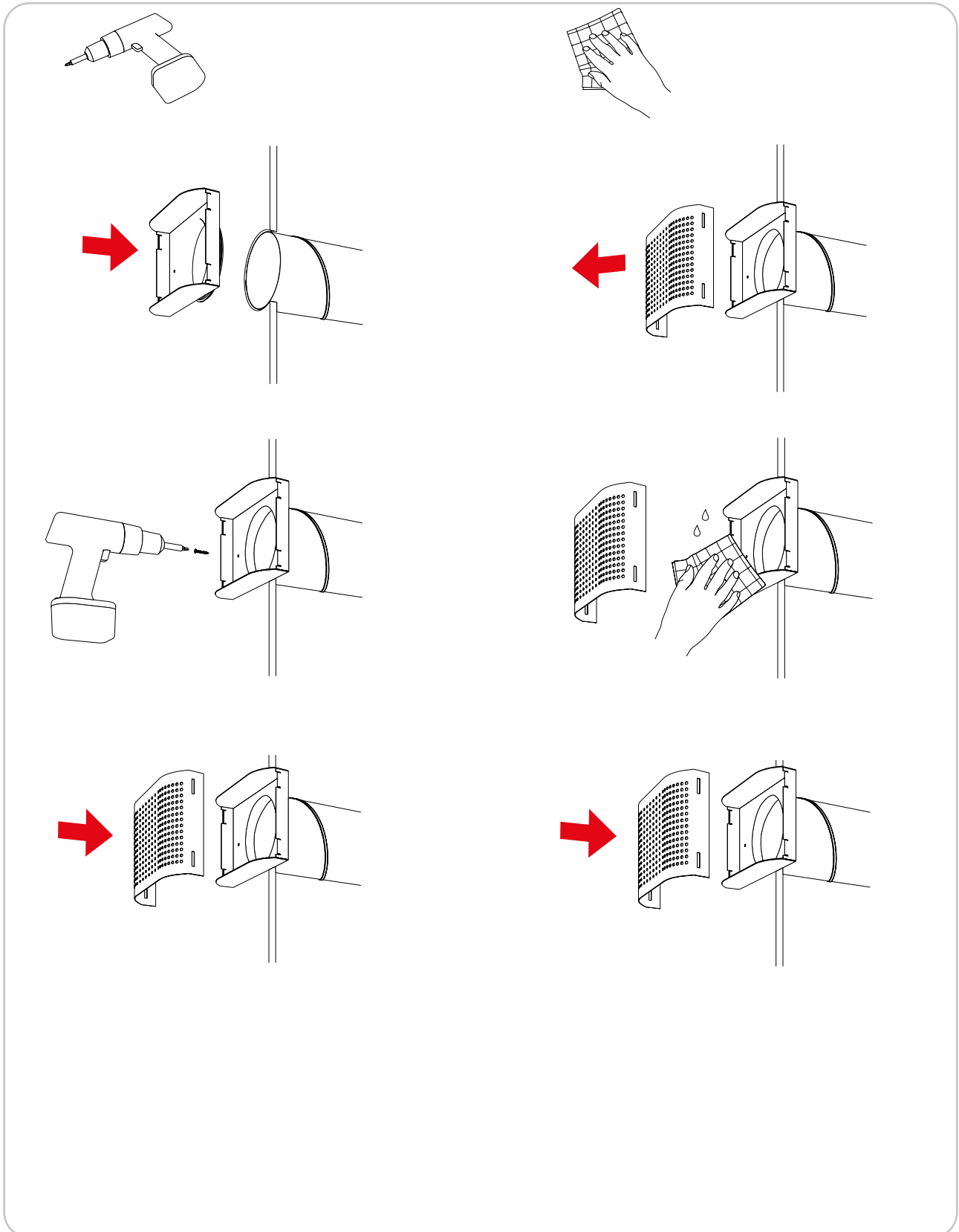

# Diffuser

## SHH

The diagram illustrates the installation of a diffuser in a duct and a speaker. It shows two measurement methods: differential pressure ( $\Delta p$ ) and air flow ( $q$ ). The  $\Delta p$  method uses a sensor grid with a red box indicating the measurement point. The  $q$  method uses a sensor grid with a red box indicating the measurement point. The  $q$  method is shown with a speaker and a sensor grid with 4 taped rows and  $n = 6$ .

Ø mm	Diffuser mounted in	Setting n [number of open rows]							
		n	2	4	6	8	10	12	14
100	Duct	k	0,7	1,2	1,7	2,3	2,7	3,1	3,6
		n	2	4	6	8	10	12	14
125	Duct	k	0,7	1,2	1,8	2,3	2,8	3,3	3,9
		n	2	4	6	8	10	12	14

# Valve

KPT

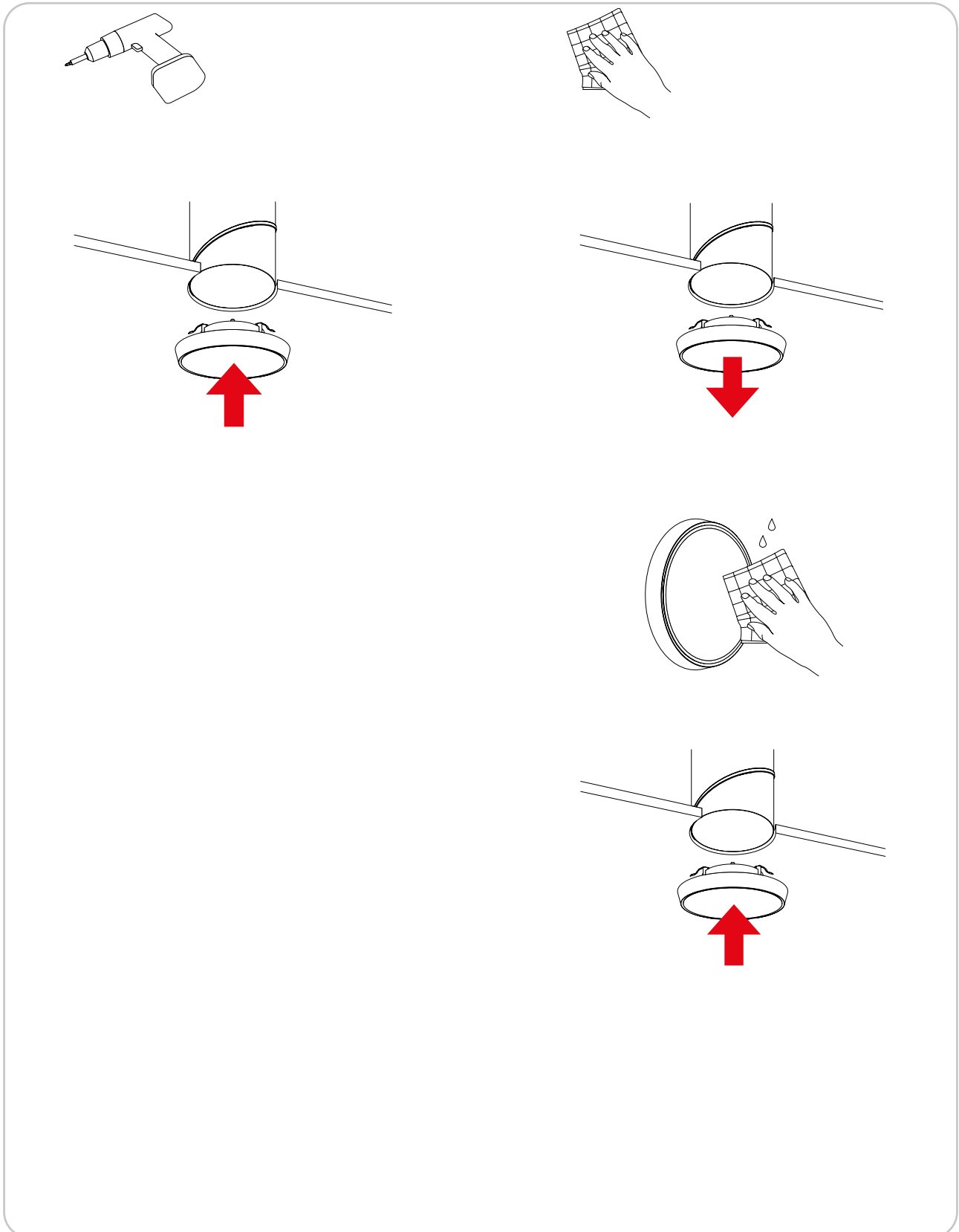

# Valve

## KPT

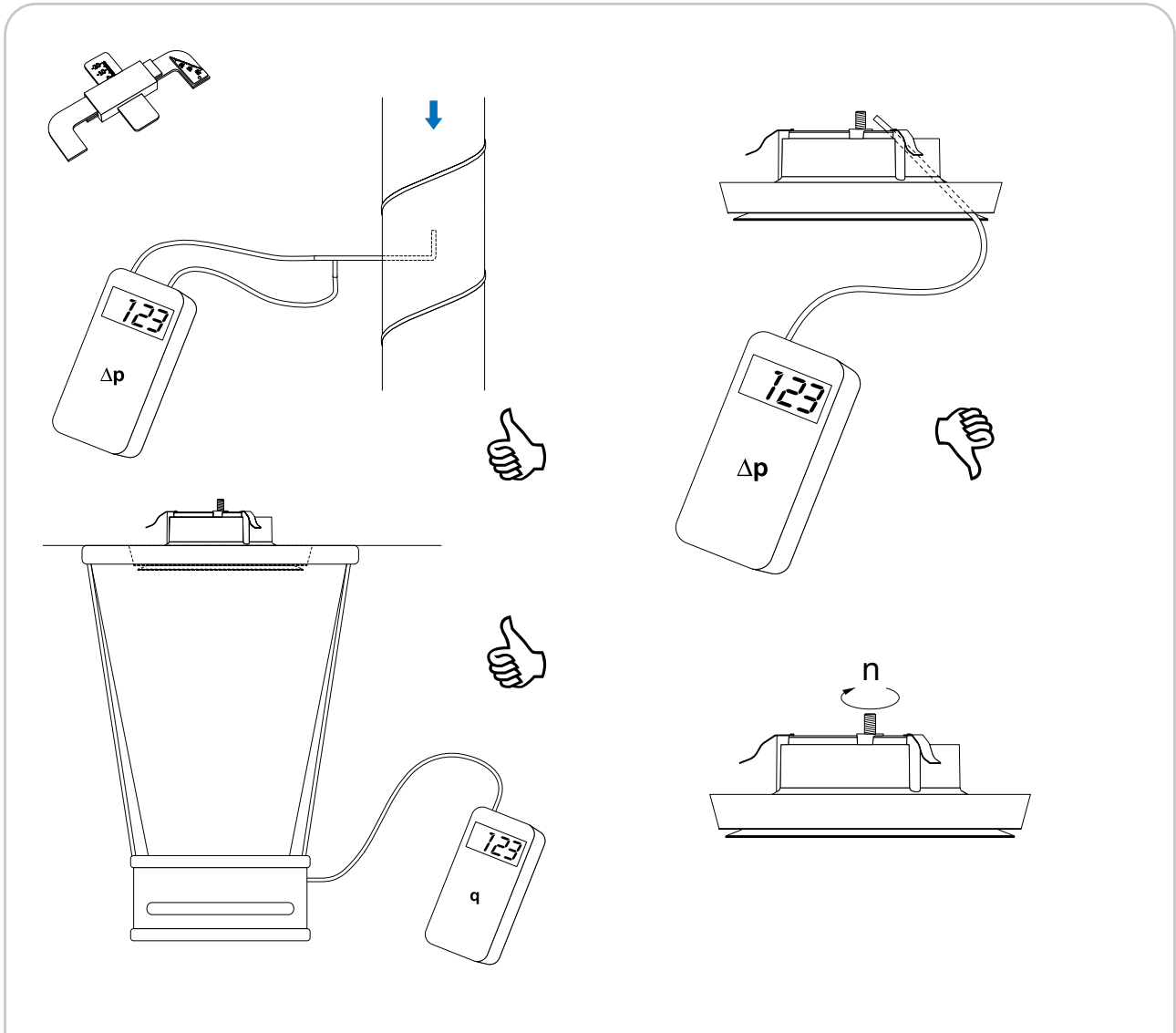

K-factors apply only to products produced after Oct 1, 2025.

Ø mm	Valve mounted in	Setting n [number of opening turns]						
		n	2	3	4	6	8	10
100	Duct	k	1,12	1,69	2,20	3,36	4,21	4,86
		n	4	5	6	7	8	9
125	Duct	k	1,23	1,50	1,79	2,09	2,30	2,66
		n	4	6	9	12	15	20
160	Duct	k	1,60	2,20	3,00	3,90	5,00	7,30
		n	7	9	11	13	15	
200	Duct	k	4,55	5,47	6,35	7,39	8,37	

# Valve

## KPT

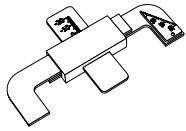

Ø mm	Valve mounted in	Setting n [number of opening turns]						
		n	1	2	3	4	6	8
80	Duct	k	1,08	1,42	1,83	2,30	2,92	3,77
		n	2	3	4	6	8	10
100	Duct	k	1,12	1,69	2,20	3,36	4,21	4,86
		n	4	5	6	7	8	9
125	Duct	k	1,23	1,50	1,79	2,09	2,30	2,66
		n	6	8	10	12		
160	Duct	k	2,34	3,06	3,73	4,35		
		n	7	9	11	13	15	
200	Duct	k	4,55	5,47	6,35	7,39	8,37	
		n						

# Valve

KI

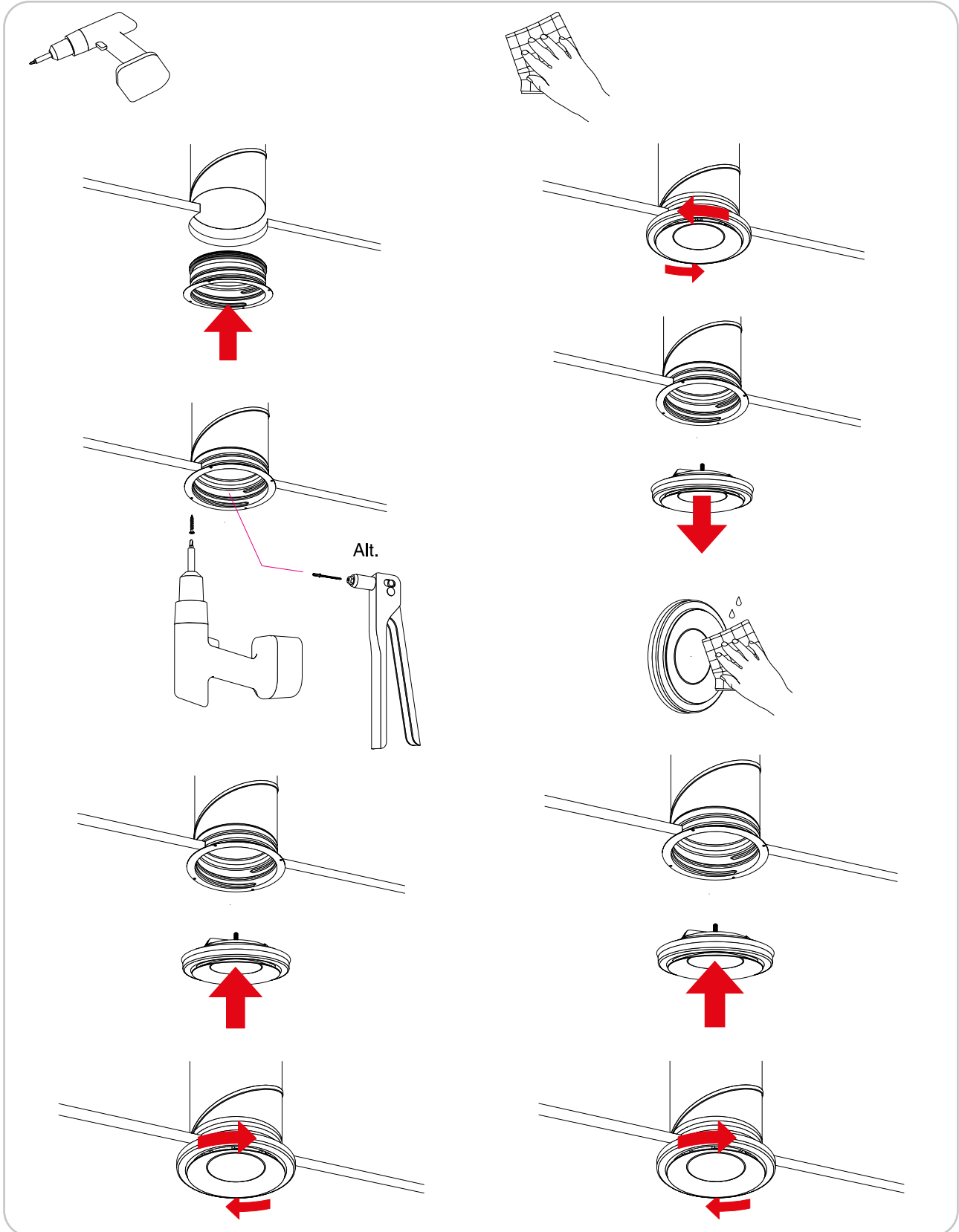

# Valve

KI

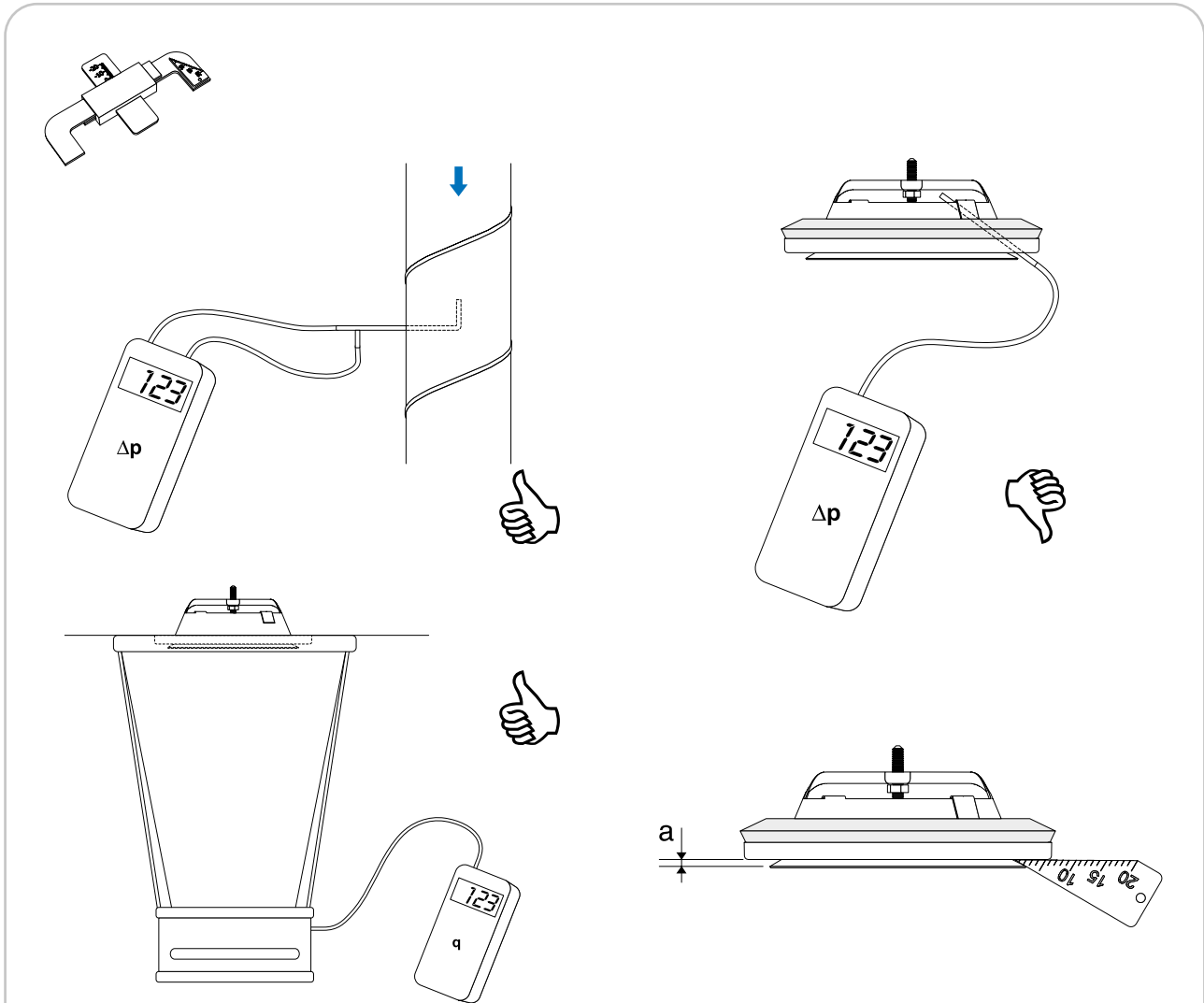

K-factors apply only to products produced after Oct 1, 2025.

Ø mm	Valve mounted in	Setting a [mm]						
		a	2	4	6	9		
80	Duct	k	0,76	1,51	2,52	4,22		
		a	2	4	6	9	12	
100	Duct	k	0,80	1,65	2,50	4,10	5,30	
		a	2	5	7	9	12	15
125	Duct	k	1,35	2,68	3,75	4,80	6,65	9,30
		a	6	9	12	15	20	
150	Duct	k	3,97	5,73	7,83	10,4	12,5	
		a	4	6	9	12	15	20
160	Duct	k	2,70	4,10	6,20	8,20	9,90	14,2
		a	5	7	9	12	15	20
200	Duct	k	4,10	5,80	7,40	9,50	12,4	15,9

# Valve

## KI

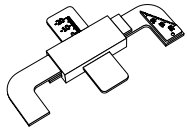

Ø mm	Valve mounted in	Setting a [mm]						
		a	2	4	6	9	12	
80	Duct	k	0,779	1,36	2,05	2,65	2,80	
		a	2	4	6	9	12	
100	Duct	k	1,00	1,10	2,31	3,19	4,12	
		a	2	4	6	9	12	
125	Duct	k	1,23	1,85	2,83	3,74	5,08	6,21
		a	3	5	7	9	12	15
150	Duct	k	2,35	3,37	4,50	5,74	7,40	10,3
		a	4	6	9	12	15	20
160	Duct	k	1,66	3,10	4,31	6,04	7,34	10,3
		a	4	6	9	12	15	20
200	Duct	k	3,66	5,17	7,05	8,00	10,4	12,9
		a	5	6	9	12	15	20

# Valve

## KIR

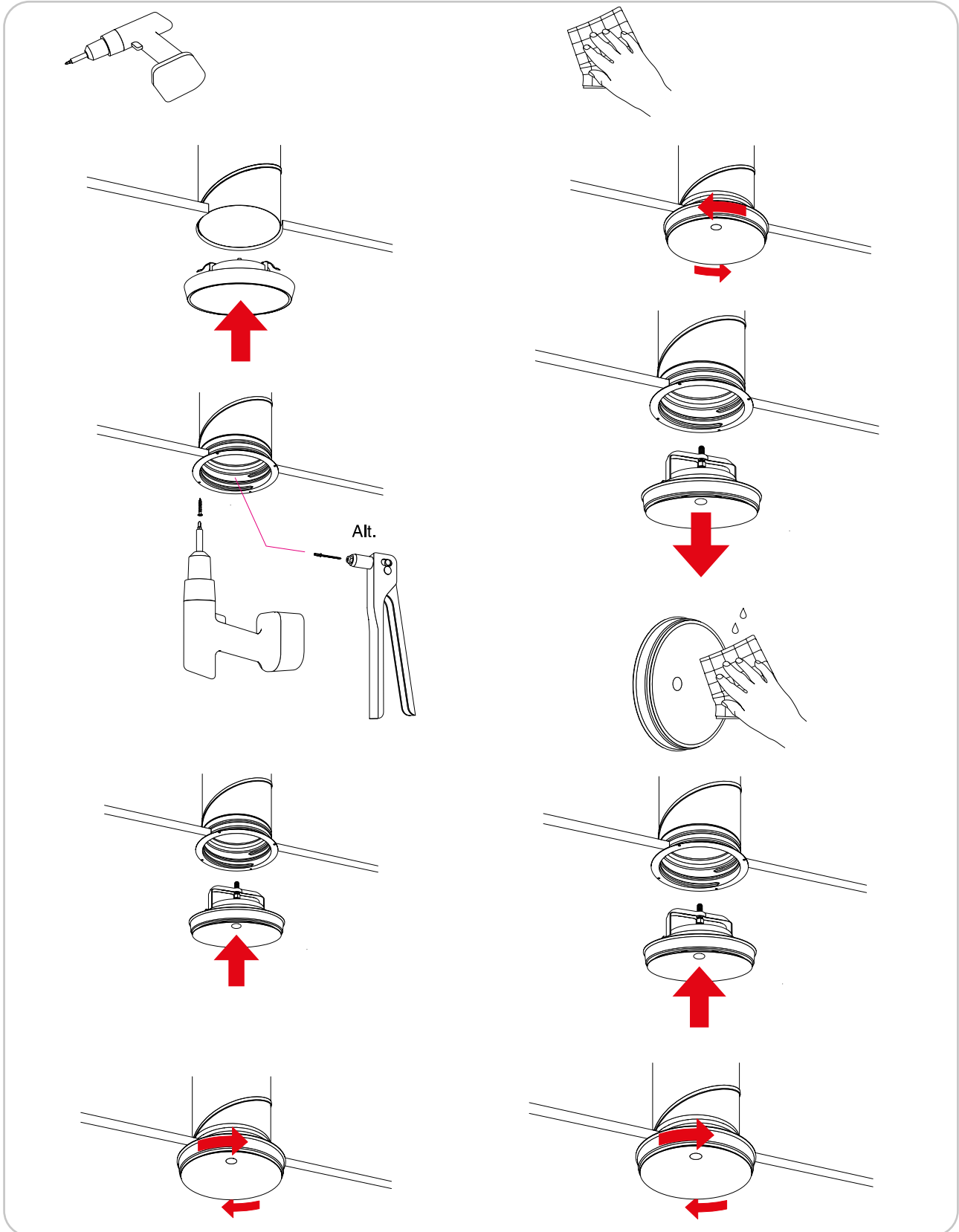

# Valve

## KIR

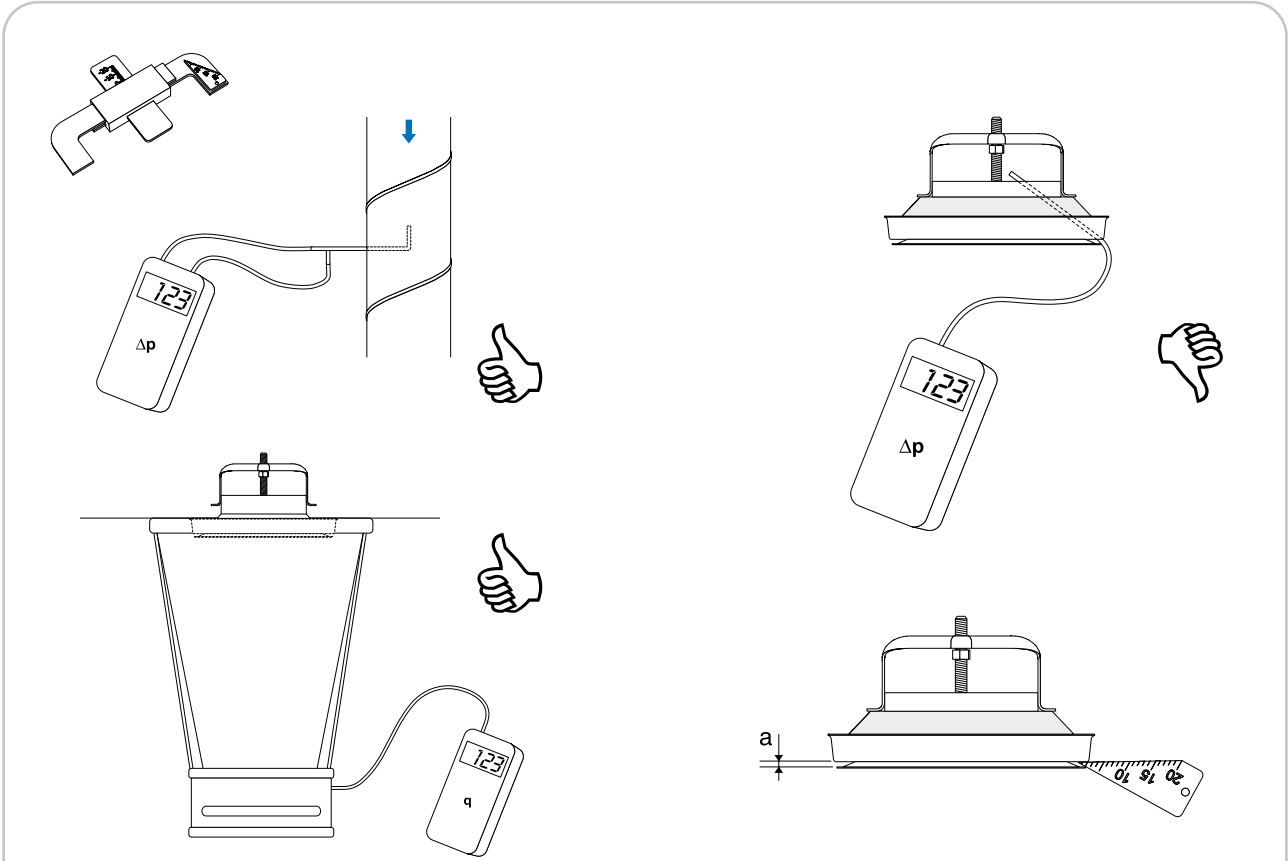

K-factors apply only to products produced after Oct 1, 2025.

### Without sector plate

Ø mm	Valve mounted in	Setting a [mm]						
		a	2	4	6	9	12	15
100	Duct	k	0,85	1,72	2,35	3,40	4,50	4,70
		a	4	6	9	12	15	
125	Duct	k	2,30	3,25	4,55	5,80	6,80	
		a	4	6	9	15	20	
160	Duct	k	3,05	4,30	6,00	10,40	12,60	
		a	4	6	9	15	20	

### With sector plate

Ø mm	Valve mounted in	Setting a [mm]						
		a	2	4	6	9	12	15
100	Duct	k	0,95	1,45	1,85	2,30	2,70	3,80
		a	4	6	9	12	15	
125	Duct	k	2,05	2,68	3,20	3,70	4,80	
		a	4	6	9	15	20	
160	Duct	k	2,70	3,90	4,75	6,40	7,70	
		a	4	6	9	15	20	

# Valve

## KIR

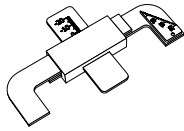

### Without sector plate

Ø mm	Valve mounted in	Setting a [mm]					
		a	2	4	6	9	12
100	Duct	k	1,09	1,56	2,11	2,81	4,31
		a	4	6	9	12	15
125	Duct	k	1,95	2,99	4,41	5,72	7,41
		a	4	6	10	15	20
160	Duct	k	2,10	3,74	5,83	9,66	12,8

### With sector plate

Ø mm	Valve mounted in	Setting a [mm]					
		a	2	4	6	9	12
100	Duct	k	0,882	1,45	1,75	2,49	2,89
		a	4	6	9	12	15
125	Duct	k	1,97	2,65	3,40	4,23	4,77
		a	4	6	10	15	20
160	Duct	k	1,69	2,73	4,39	5,91	7,35

# Valve

## TAV

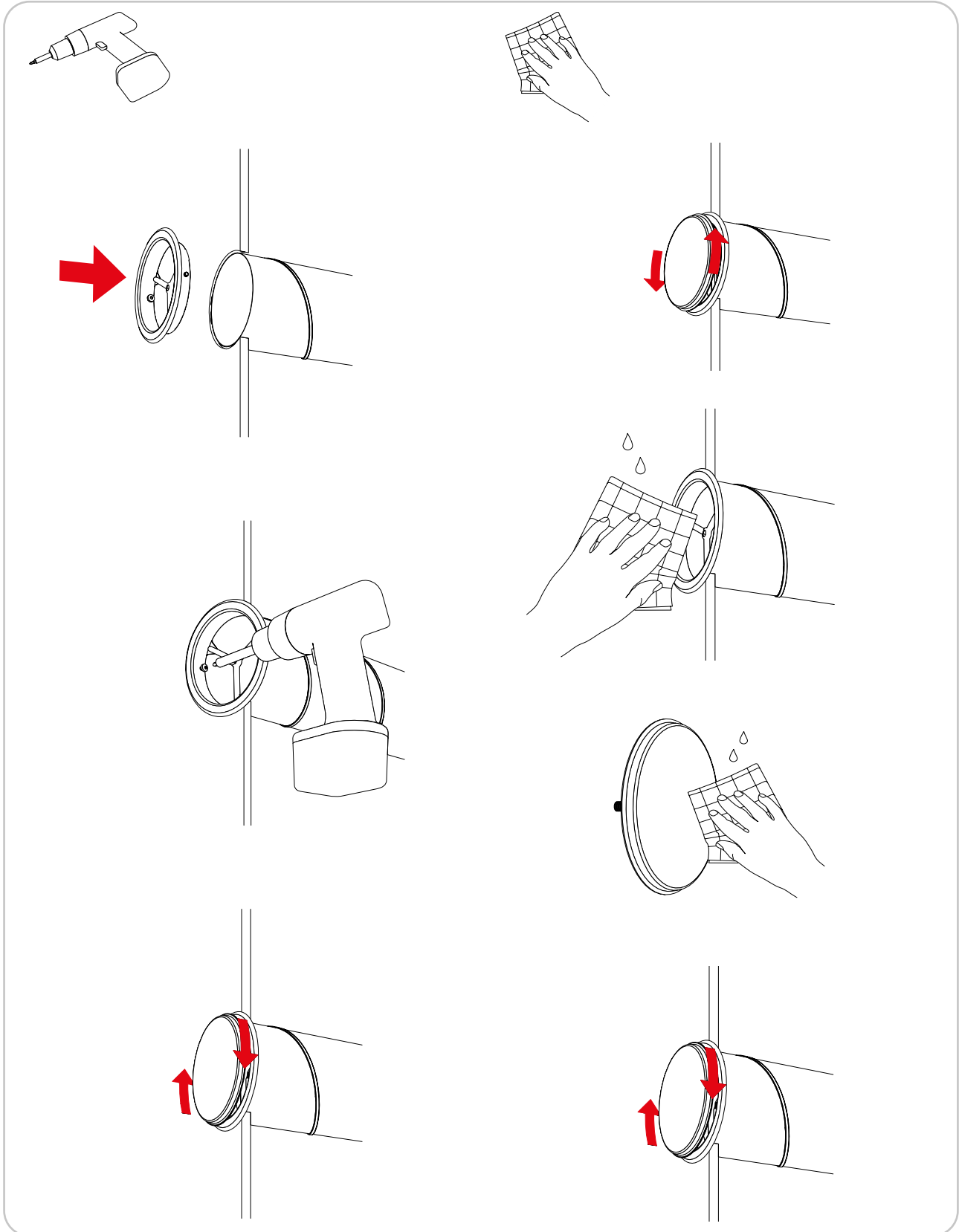

# Valve

## KVB

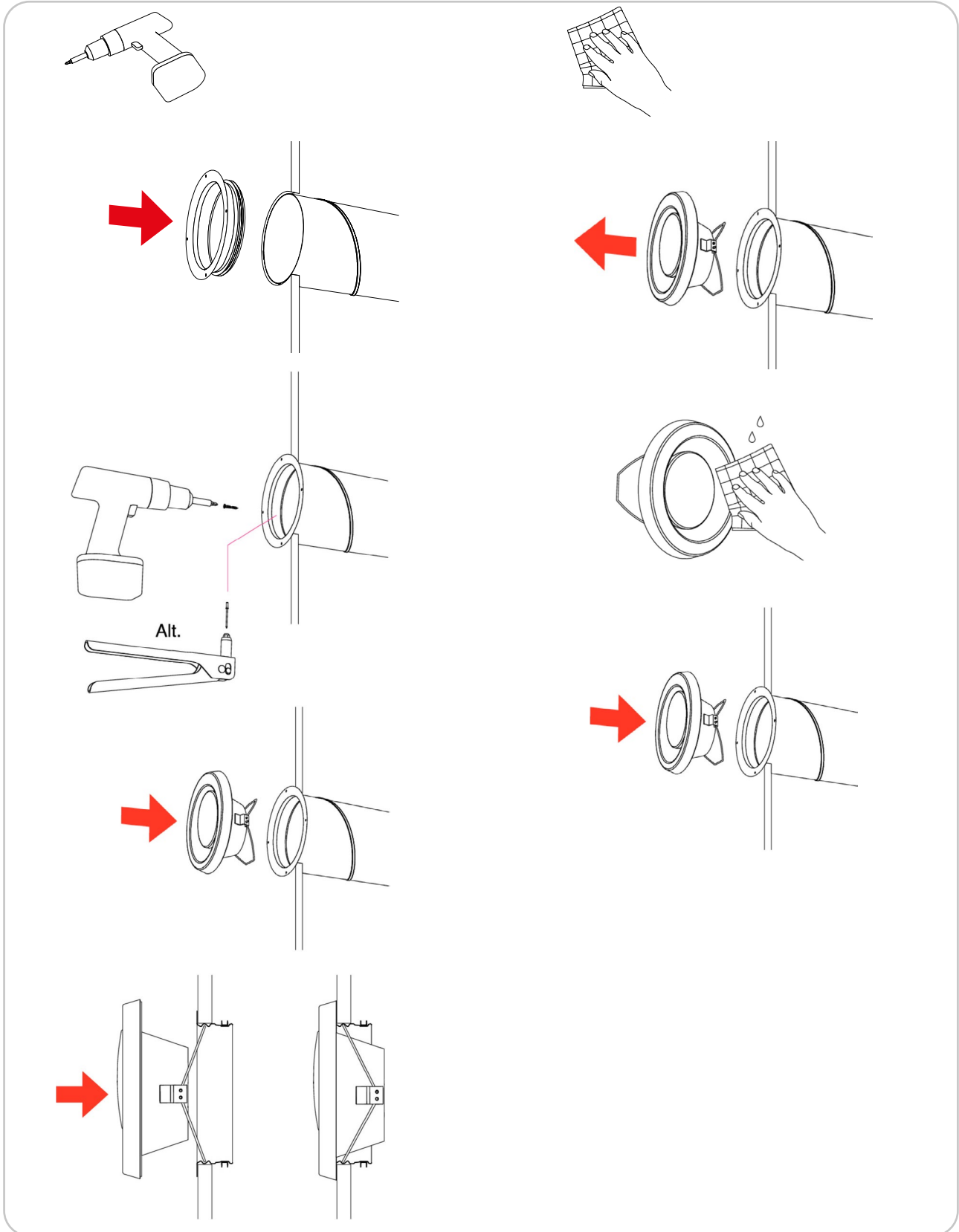

# Valve

## KVB

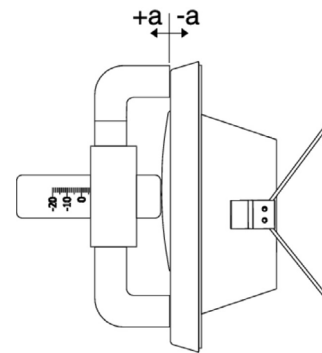
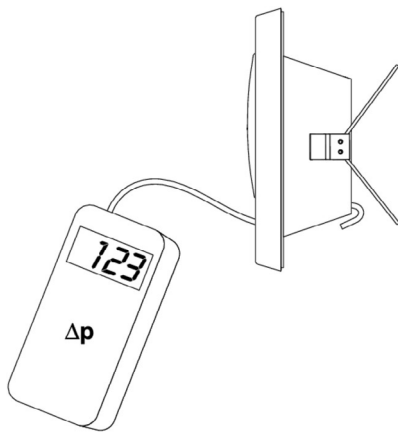
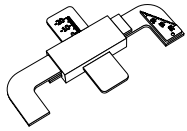

K-factors apply only to products produced after Oct 1, 2025.

Ø mm	Valve mounted in	Setting a [mm]									
		a	-11	-9	-6	-3	0	3	6	10	
100	Duct	k	0,40	0,55	0,80	1,10	1,40	1,70	2,00	2,30	
		a	-20	-16	-12	-8	-4	0	4	8	
125	Duct	k	1,10	1,40	2,00	2,30	2,80	3,20	3,60	4,00	
		a	-23	-20	-15	-10	-5	0	5	10	15
160	Duct	k	1,70	1,90	3,00	4,20	5,50	6,70	7,90	8,90	10,5

# Valve

## KVB

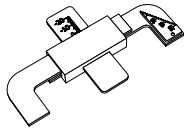

Ø mm	Valve mounted in	Setting a [mm]						
		a	-11	-9	-6	0	6	9
100	Duct	a	0,389	0,547	0,818	1,37	1,87	2,08
	Bend 90°	k	0,382	0,540	0,830	1,41	1,98	2,20
	T-piece		0,393	0,551	0,851	1,45	1,98	2,18
125	Duct	a	-18	-12	-6	0	6	
	Bend 90°	k	1,32	1,88	2,47	3,01	3,46	
	T-piece		1,26	1,80	2,46	2,90	3,46	
160	Duct	a	-24	-18	-12	-6	0	6
	Bend 90°	k	2,05	2,50	3,31	4,23	5,11	5,73
	T-piece		1,76	2,33	3,15	3,93	4,72	5,29
			-	2,80	3,29	4,04	4,88	5,41

# Valve

## KDPF

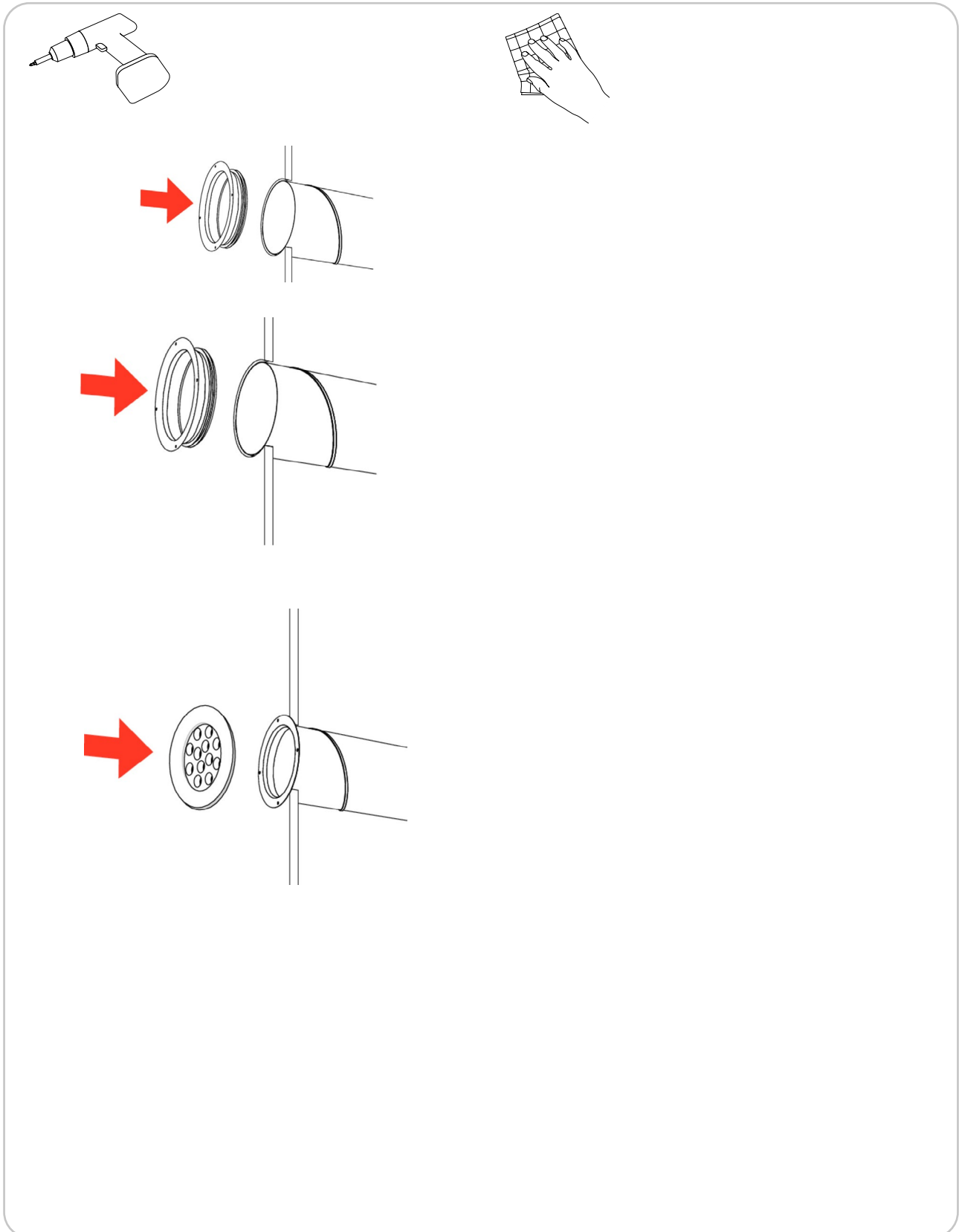

# Valve

## KDPF

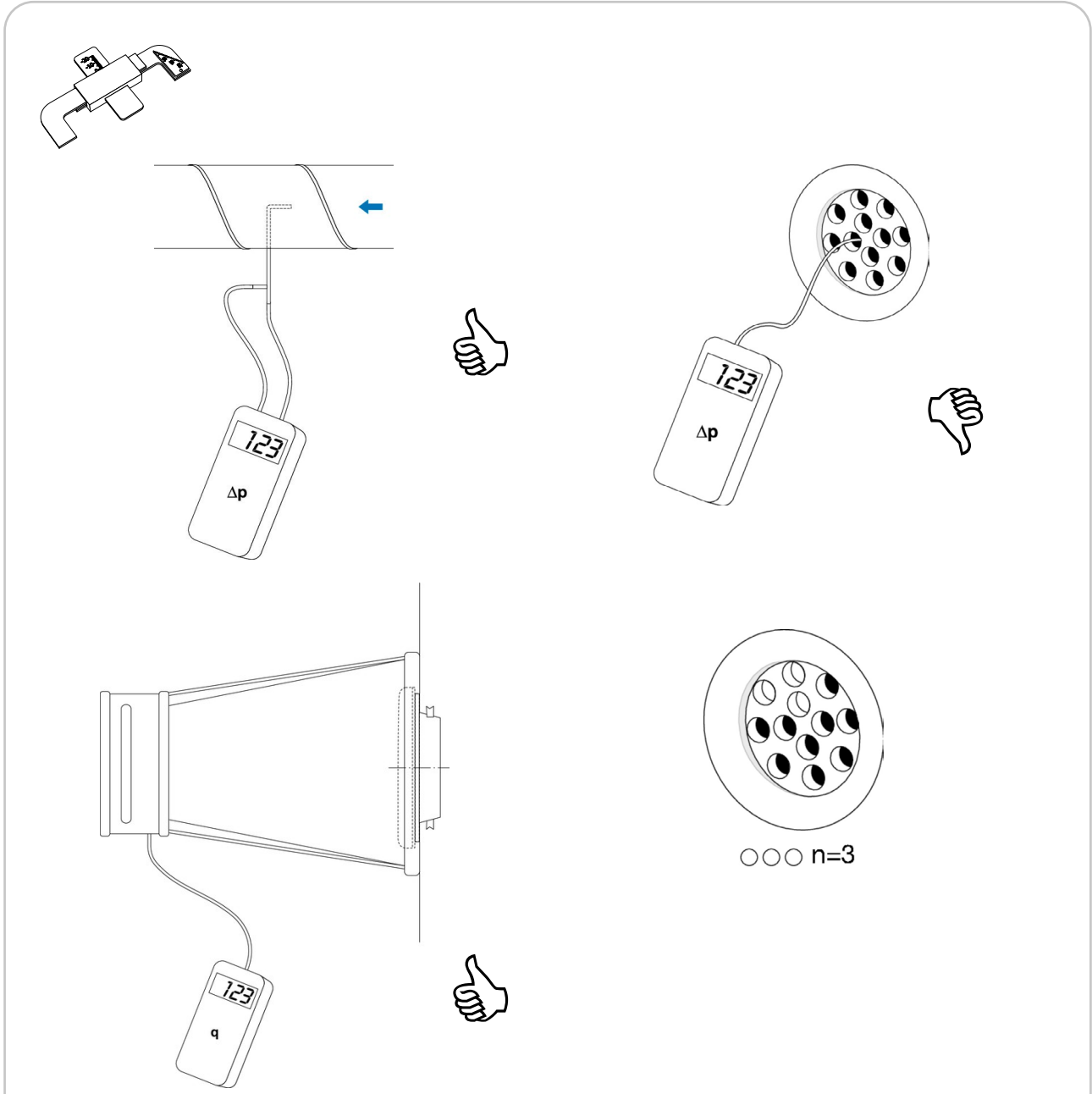

K-factors apply only to products produced after Oct 1, 2025.

Ø mm	Valve mounted in	Setting n [number of open holes]							
		n	2	3	4	6	8	10	12
100	Duct	k	0,60	0,72	0,93	1,28	1,69	2,20	2,65

# Valve

## KDPF

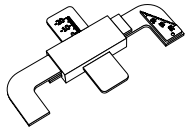

Ø mm	Valve mounted in	Setting n [number of open holes]						
		n	1	2	3	4	5	6
100	Duct	k	0,24	0,42	0,59	0,80	0,98	1,20
		n	7	8	9	10	11	12
	Duct	k	1,50	1,60	1,80	2,10	2,30	2,50
		n						

# Valve

KVG Ø100–160

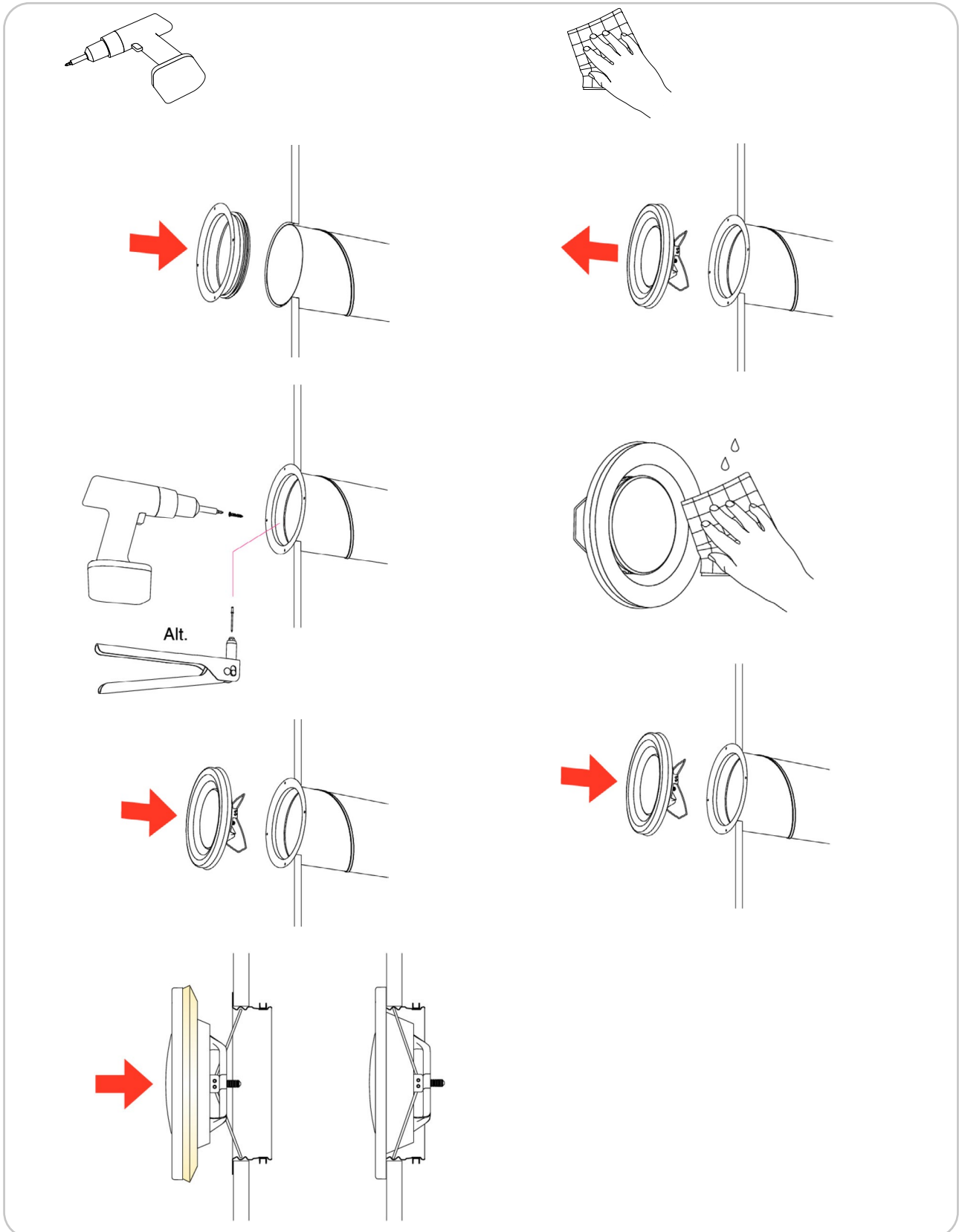

# Valve

KVG Ø100–160

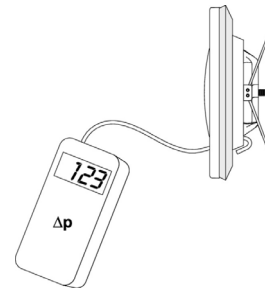
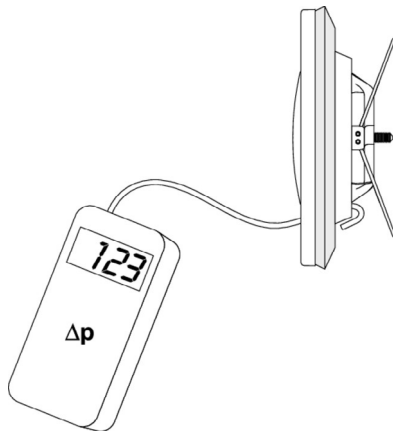
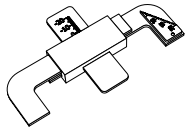

K-factors apply only to products produced after Oct 1, 2025.

Ø mm	Valve mounted in	Setting a [mm]									
		a	-9	-6	-3	0	3	6	9	12	15
100	Duct	k	0,70	1,10	1,40	1,80	2,10	2,50	2,90	3,30	3,30
		a	-17	-13	-9	-6	-3	0	5	10	15
125	Duct	k	0,90	1,40	2,10	2,70	3,10	3,50	4,30	5,00	5,80
		a	-20	-15	-10	-5	0	5	10	15	20
160	Duct	k	0,70	1,60	2,60	3,60	4,50	4,50	5,50	6,50	7,50
		a	-20	-15	-10	-5	0	5	10	15	20

# Valve

## KVG Ø100–160

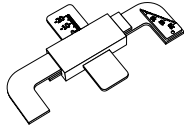

Ø mm	Valve mounted in	Setting a [mm]									
		a	-9	-5	0	5	8	12			
100	Duct	a	0,577	1,25	1,85	2,39	2,75	3,07			
	Bend 90°	k	0,549	1,15	1,87	2,53	2,86	3,27			
	T-piece		0,788	1,34	1,78	2,37	2,89	2,99			
125	Duct	a	-17	-13	-9	-6	-3	0	5	10	15
	Bend 90°	k	0,736	1,27	1,96	2,41	2,93	3,36	3,96	4,79	5,85
	T-piece		0,651	1,31	2,06	2,49	3,35	3,62	5,03	5,43	7,05
160	Duct	a	-18	-14	-10	-5	0	6	12	18	
	Bend 90°	k	1,05	1,68	2,33	3,50	4,60	5,62	6,58	7,70	
	T-piece		1,05	1,71	2,48	3,43	4,35	5,25	6,33	7,49	
			-	1,91	2,68	3,54	4,40	5,60	6,80	7,49	

# Valve

KVG Ø200

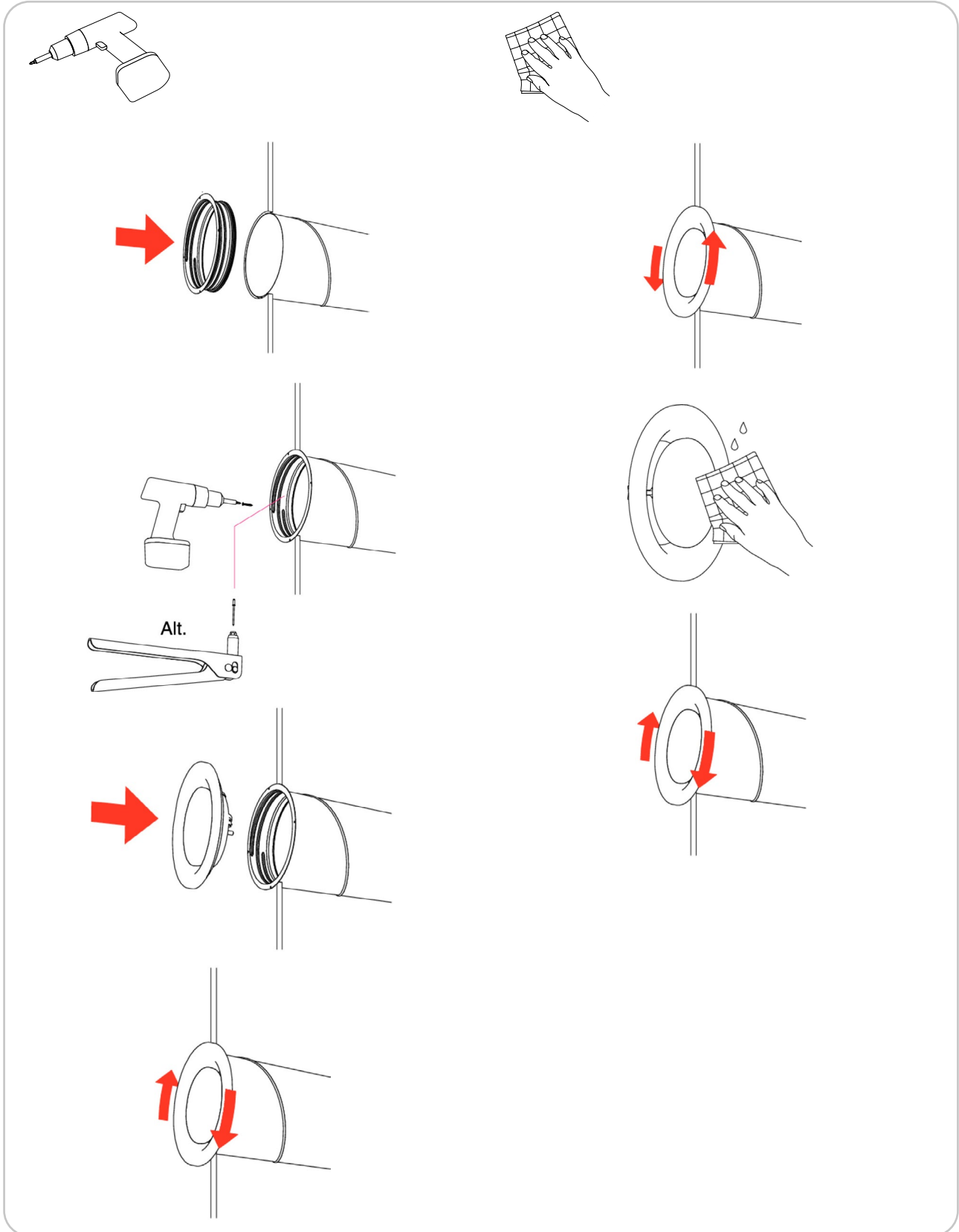

# Valve

KVG Ø200

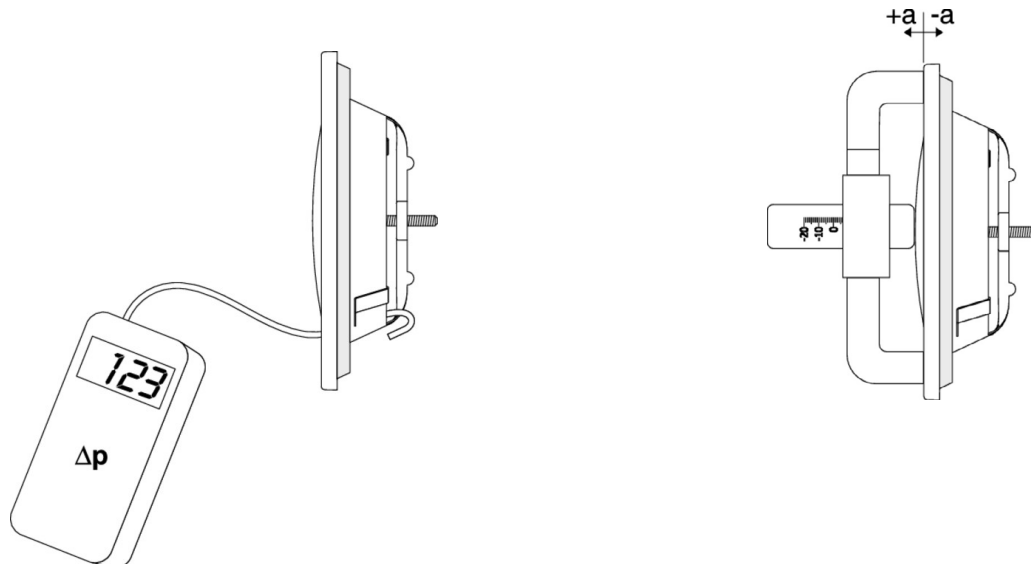
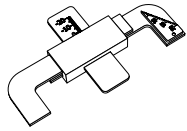

K-factors apply only to products produced after Oct 1, 2025.

Ø mm	Valve mounted in	Setting a [mm]								
		a k	-20	-15	-10	-5	0	5	10	15
200	Duct	k	1,90	3,00	4,20	5,50	6,70	7,90	8,90	10,50

# Valve

KVG Ø200

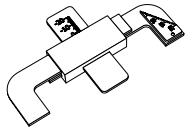

Ø mm	Valve mounted in	Setting a [mm]								
		a	-23	-18	-15	-10	-5	0	10	20
200	Duct		1,94	3,23	3,94	4,94	6,32	7,80	10,0	12,6
	Bend 90°	k	1,86	2,99	3,95	5,08	6,14	7,62	10,1	11,2
	T-piece		–	3,28	4,02	5,36	6,75	7,57	10,5	12,5

# Valve

KU

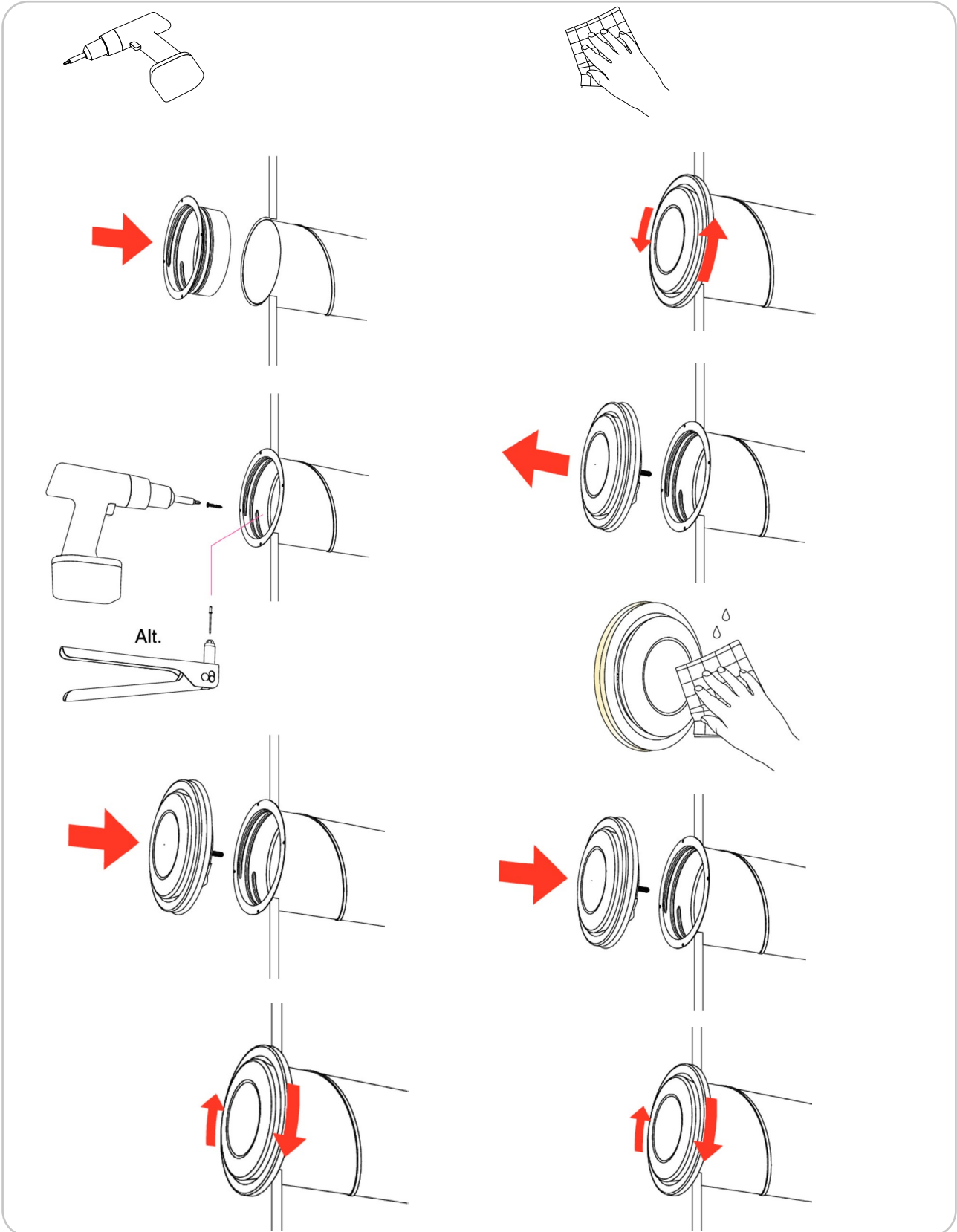

# Valve

## KU

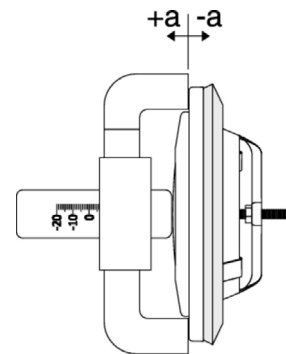
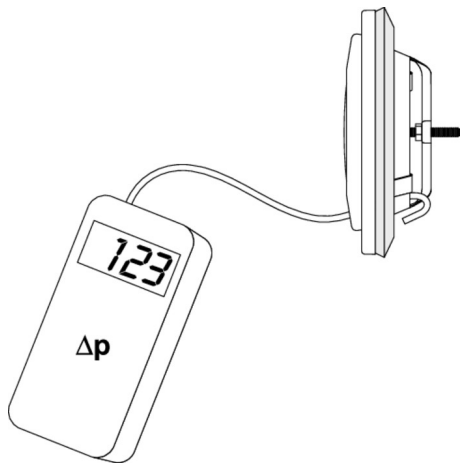
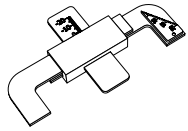

K-factors apply only to products produced after Oct, 1, 2025.

Ø mm	Valve mounted in	Setting a [mm]									
		a	-9	-6	-3	0	3	6			
80	Duct	k	0,62	0,85	1,25	1,42	1,70	2,00			
		a	-12	-9	-5	0	5	10			
100	Duct	k	0,45	0,75	1,05	1,75	2,40	3,05			
		a	-16	-13	-9	-6	-3	0	5	10	
125	Duct	k	0,35	0,85	1,41	1,85	2,22	2,69	3,42	4,37	
		a	-15	-12	-9	-6	-3	0	3	6	9
150	Duct	k	1,45	2,00	2,50	3,10	3,60	4,10	4,68	5,30	5,80
		a	-15	-10	-5	0	5	10	15	20	
160	Duct	k	1,15	2,11	3,10	3,95	5,10	6,35	7,60	8,90	
		a	-20	-15	-10	-5	0	5	10	15	20
200	Duct	k	2,75	4,00	5,20	6,30	7,50	8,80	10,0	11,6	12,8
		a	-20	-15	-10	-5	0	5	10	15	20

# Valve

## KU

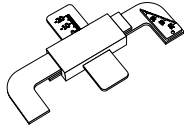

Ø mm	Valve mounted in	Setting a [mm]									
		a	-9	-6	-3	0	3	6			
80	Duct	a	0,679	0,941	1,32	1,59	1,90	2,13			
	Bend 90°	k	0,715	1,02	1,23	1,54	1,75	2,06			
	T-piece		0,732	1,00	1,35	1,54	1,79	1,95			
100	Duct	a	0,560	0,938	1,46	2,00	2,72				
	Bend 90°	k	0,632	1,02	1,44	2,20	2,78				
	T-piece		-	1,08	1,54	2,17	2,91				
125	Duct	a	0,681	0,868	1,45	1,72	2,33	2,73	3,31	3,95	
	Bend 90°	k	0,616	0,854	1,40	1,86	2,35	2,75	3,11	4,01	
	T-piece		-	1,13	1,56	1,97	2,39	3,00	3,40	4,19	
150	Duct	a	1,47	2,12	2,62	3,83	4,82	5,96			
	Bend 90°	k	1,60	2,01	2,61	4,00	4,96	6,61			
	T-piece		1,79	2,44	3,07	4,09	5,21	6,46			
160	Duct	a	0,833	1,00	1,79	2,66	3,68	4,66	5,92	6,57	7,04
	Bend 90°	k	0,879	1,09	1,71	2,62	3,63	4,59	5,68	6,61	6,90
	T-piece		-	1,58	2,11	3,09	3,90	4,90	6,10	6,86	7,11
200	Duct	a	2,39	3,65	5,02	5,77	7,18	8,39	11,4	13,7	
	Bend 90°	k	2,39	3,54	4,87	5,70	7,01	8,51	11,1	13,6	
	T-piece		2,39	4,04	5,15	6,33	7,58	8,45	10,9	14,3	

# Valve

## KSU

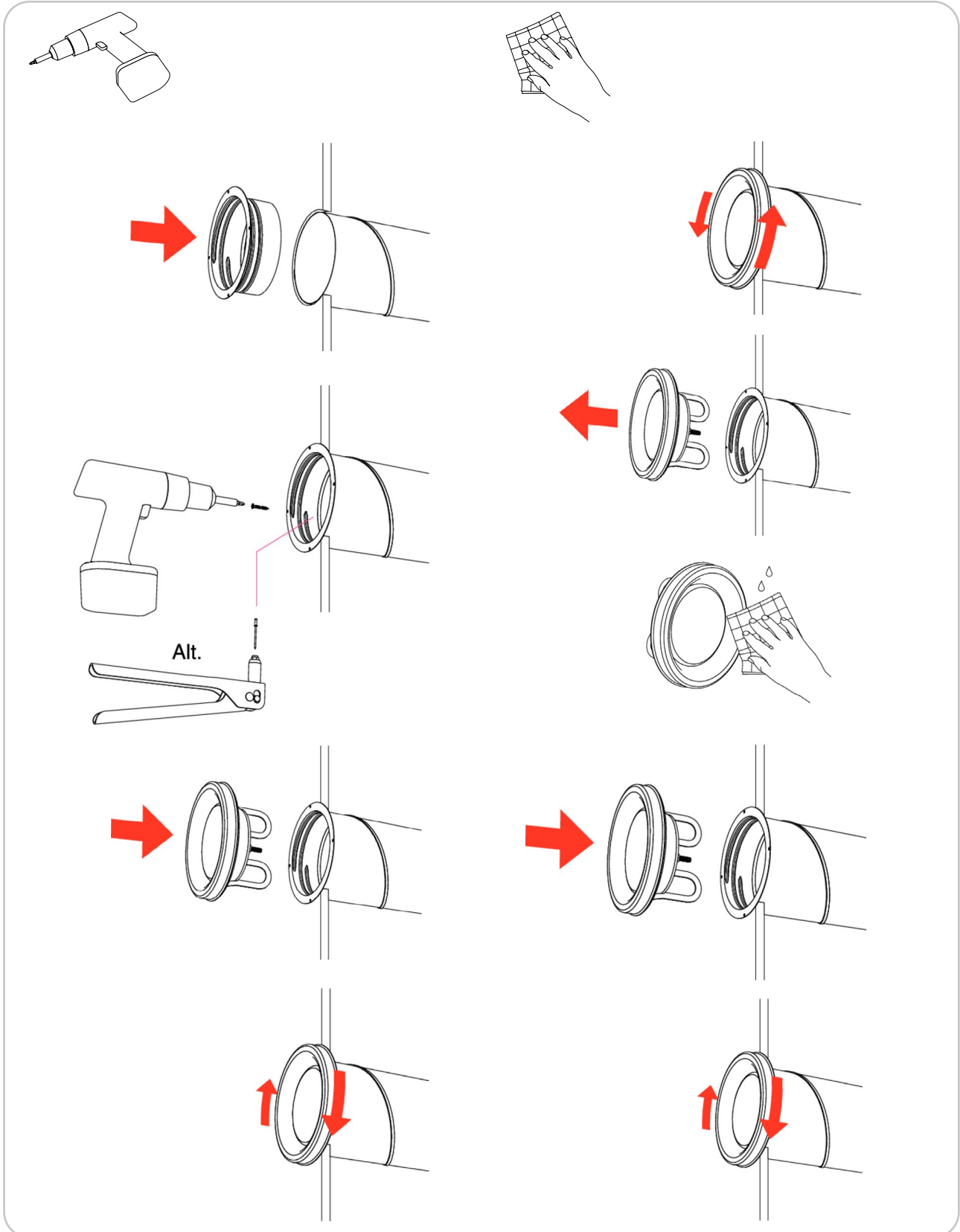

# Valve

## KSU

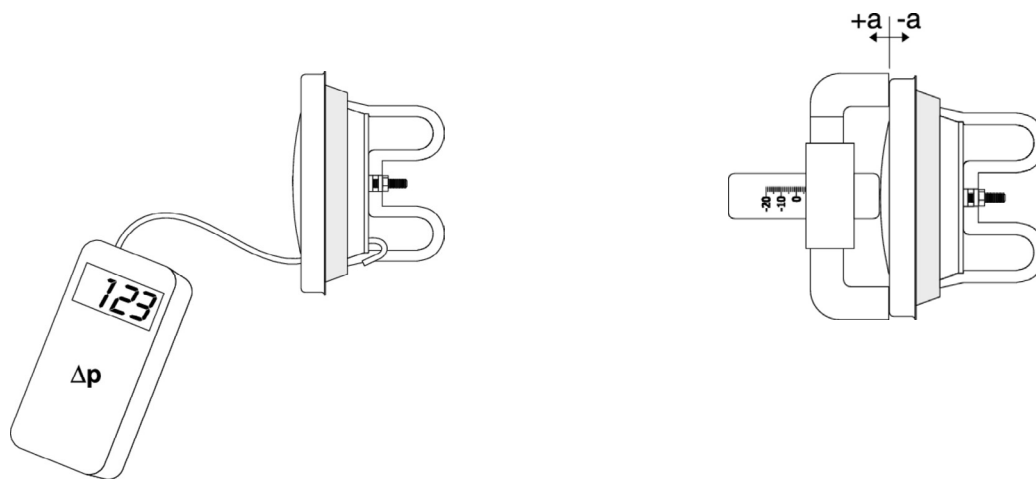
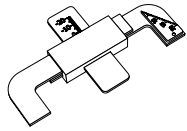

K-factors apply only to products produced after Oct, 1, 2025.

Ø mm	Valve mounted in	Setting a [mm]							
		a	-10	-7	-5	0	5	10	15
100	Duct	k	0,37	0,67	0,87	1,29	1,78	2,35	2,80
		a	-10	-5	0	5	10		
125	Duct	k	0,76	1,34	1,94	2,57	3,15		
		a	-10	-5	0	5	10		
150	Duct	k	1,68	2,47	3,31	4,07	4,87	5,79	6,67
		a	-10	-5	0	5	10	15	20
160	Duct	k	1,68	2,47	3,31	4,07	4,87	6,46	6,67
		a	-10	-5	0	5	10	15	20
200	Duct	k	1,40	2,55	3,75	5,00	6,30	7,60	
		a	-5	0	5	10	15	20	

# Valve

## KSU

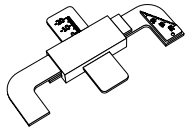

Ø mm	Valve mounted in	Setting a [mm]							
		a	-15	-12	-10	-5	0	5	10
100	Duct	a	0,459	0,676	0,861	1,36	1,82	2,32	2,75
	Bend 90°	k	0,505	0,841	1,00	1,40	1,86	2,35	2,77
	T-piece		0,576	0,850	1,01	1,42	1,89	2,35	2,66
125	Duct	a	-10	-5	0	5	10		
	Bend 90°	k	1,29	1,93	2,59	3,29	3,91		
	T-piece		1,24	1,90	2,61	3,33	3,90		
150	Duct	a	-10	-5	0	5	10	15	
	Bend 90°	k	1,81	2,69	3,42	4,48	5,17	6,09	
	T-piece		2,01	2,75	3,47	4,37	5,29	6,21	
160	Duct	a	-10	-5	0	5	10	15	
	Bend 90°	k	1,80	2,62	3,62	4,57	5,58	6,46	
	T-piece		1,50	2,50	3,48	4,50	5,39	6,52	
200	Duct	a	-3	0	5	10	15	20	25
	Bend 90°	k	2,02	2,72	3,85	5,19	6,32	7,63	8,72
	T-piece		1,65	2,62	3,71	5,21	6,07	7,40	8,60
			2,11	3,00	3,90	5,46	6,54	7,80	8,90

# Valve

KPF

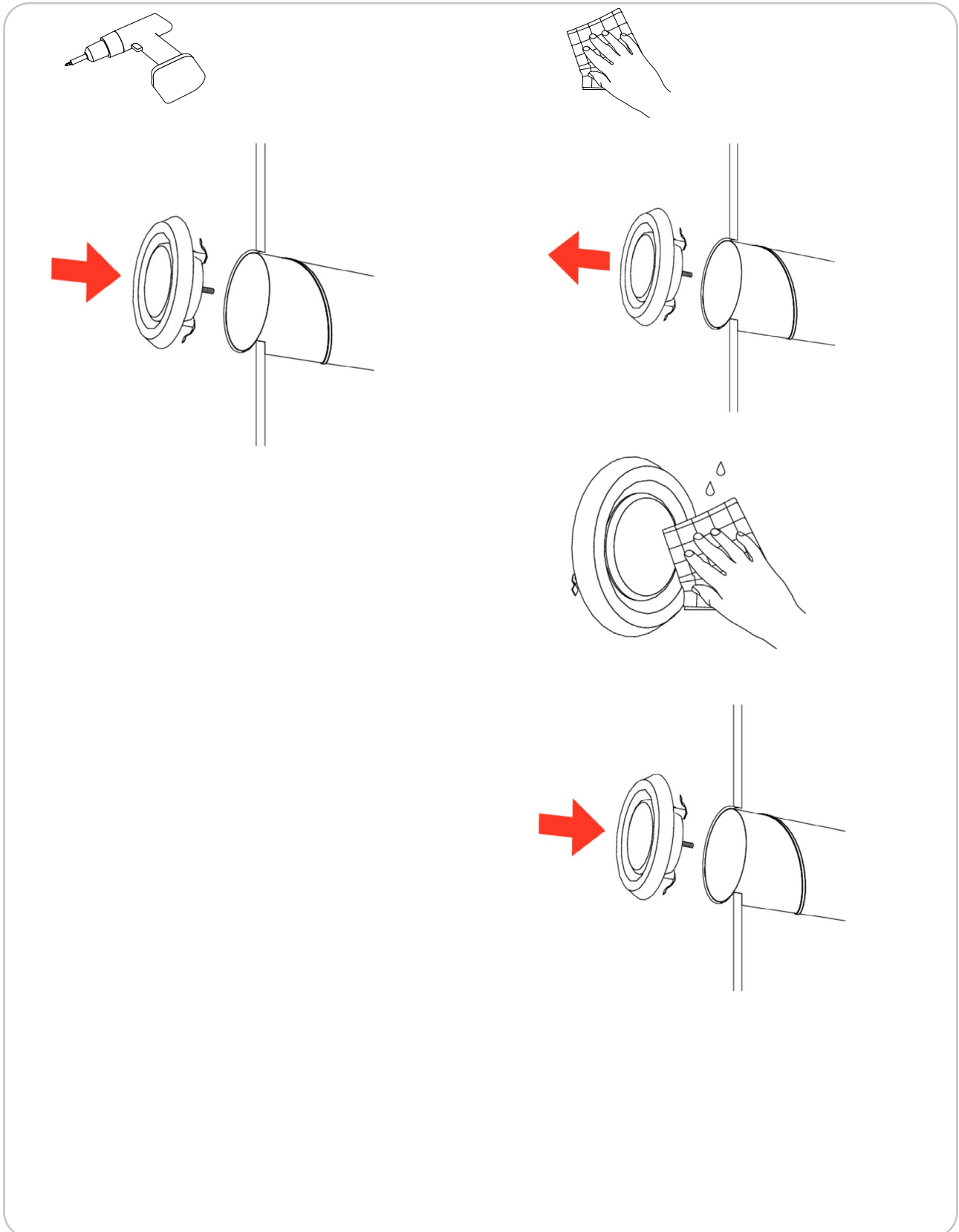

# Valve

## KPF

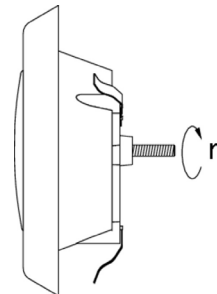
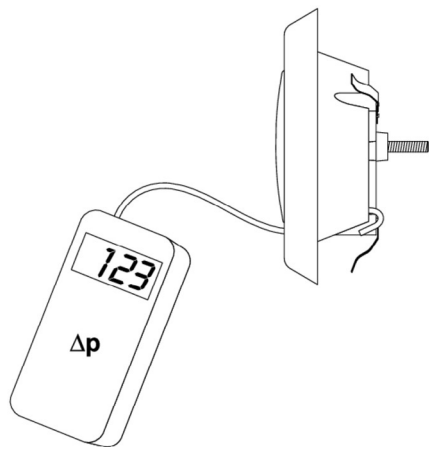
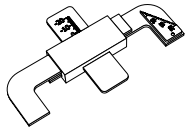

K-factors apply only to products produced after Oct, 1, 2025.

Ø mm	Valve mounted in	Setting n [number of opening turns]						
		n	0	3	6	9	12	15
80	Duct	k	0,68	0,81	0,95	1,11	1,25	1,35
		n	0	3	6	12	15	18
100	Duct	k	1,54	1,71	1,96	2,48	2,91	3,17
		n	0	3	6	9	12	15
125	Duct	k	1,72	1,99	2,35	2,69	2,98	3,31
		n	0	3	6	9	12	15
160	Duct	k	0,90	1,30	1,80	2,70	3,20	3,70
		n	-3	0	3	6	9	15
200	Duct	k	1,77	2,57	3,26	4,23	4,93	5,84
		n	3	6	9	12	15	18

# Valve

## KPF

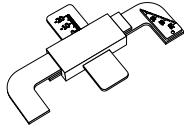

Ø mm	Valve mounted in	Setting n [number of opening turns]						
		n	0	3	6	9	12	15
80	Duct	n	0,489	0,675	1,08	1,07	1,55	1,42
	Bend 90°	k	0,517	0,621	0,867	1,10	1,31	1,42
	T-piece		–	0,715	0,915	1,14	1,18	1,41
100	Duct	n	0	3	6	9	15	18
	Bend 90°	k	1,54	1,71	1,96	2,48	2,91	3,17
	T-piece		1,58	1,89	2,20	2,62	2,94	3,39
125	Duct	n	0	3	6	9	12	15
	Bend 90°	k	1,76	1,99	2,44	2,89	3,31	3,67
	T-piece		1,82	1,95	2,42	2,74	3,21	3,56
160	Duct	n	3	6	9	12	15	18
	Bend 90°	k	1,54	2,19	2,78	3,20	3,94	4,46
	T-piece		1,41	1,97	2,52	3,04	3,63	4,23
200	Duct	n	3	6	9	12	15	18
	Bend 90°	k	1,77	2,57	3,26	4,23	4,93	5,84
	T-piece		1,78	2,45	3,26	3,48	4,89	5,14
			–	2,53	3,03	3,79	4,55	5,04





Most of us spend the majority of our time indoors. Indoor climate is crucial to how we feel, how productive we are and if we stay healthy.

We at Lindab have therefore made it our most important objective to contribute to an indoor climate that improves people's lives. We do this by developing energy-efficient ventilation solutions and durable building products. We also aim to contribute to a better climate for our planet by working in a way that is sustainable for both people and the environment.

Lindab | For a better climate